

---

# Contents

|                                |     |
|--------------------------------|-----|
| Introduction .....             | 2   |
| In brief .....                 | 6   |
| Keys, doors and windows .....  | 17  |
| Seats, restraints .....        | 33  |
| Storage .....                  | 47  |
| Instruments and controls ..... | 56  |
| Lighting .....                 | 75  |
| Climate control .....          | 80  |
| Driving and operating .....    | 84  |
| Vehicle care .....             | 99  |
| Service and maintenance .....  | 135 |
| Technical data .....           | 139 |
| Customer information .....     | 155 |
| Index .....                    | 156 |

## Introduction

|               |                             |                      |                      |                      |
|---------------|-----------------------------|----------------------|----------------------|----------------------|
| Fuel          | Designation                 | <input type="text"/> |                      |                      |
| Engine oil    | Grade                       | <input type="text"/> |                      |                      |
|               | Viscosity                   | <input type="text"/> |                      |                      |
| Tyre pressure | Tyre size                   |                      | Front                | Rear                 |
|               | Summer tyres                | <input type="text"/> | <input type="text"/> | <input type="text"/> |
|               | Winter tyres                | <input type="text"/> | <input type="text"/> | <input type="text"/> |
| Weights       | Gross vehicle weight rating | <input type="text"/> |                      |                      |
|               | - Kerb weight, basic model  | <input type="text"/> |                      |                      |
|               | - Additional weight         | <input type="text"/> |                      |                      |
|               | - Heavy accessories         | <input type="text"/> |                      |                      |
|               | = Loading                   | <input type="text"/> |                      |                      |

## Vehicle specific data

Please enter your vehicle's data on the previous page to keep it easily accessible. This information is available under the sections "Service and Maintenance" and "Technical data" as well as on the identification plate.

## Introduction

Your vehicle is a designed combination of advanced technology, safety, environmental friendliness and economy.

This Owner's Manual provides you with all the necessary information to enable you to drive your vehicle safely and efficiently.

Make sure your passengers are aware of the possible risk of accident and injury which may result from improper use of the vehicle.

You must always comply with the specific laws and regulations of the country that you are in. These laws may differ from the information in this Owner's Manual.

When this Owner's Manual refers to a workshop visit, we recommend your Opel Service Partner.

When this Owner's Manual refers to a workshop visit, we recommend your Vauxhall Authorised Repairer.

All Opel Service Partners provide first-class service at reasonable prices. Experienced mechanics trained by Opel work according to specific Opel instructions.

All Vauxhall Authorised Repairers provide first-class service at reasonable prices. Experienced mechanics trained by Vauxhall work according to specific Vauxhall instructions.

The customer literature pack should always be kept ready to hand in the vehicle.

## Using this manual

- This manual describes all options and features available for this model. **Certain descriptions, including those for display and menu functions, may not apply to**

**your vehicle due to model variant, country specifications, special equipment or accessories.**

- The "In brief" section will give you an initial overview.
- The table of contents at the beginning of this manual and within each section shows where the information is located.
- The index will enable you to search for specific information.
- This Owner's Manual depicts left-hand drive vehicles. Operation is similar for right-hand drive vehicles.
- The Owner's Manual uses the factory engine designations. The corresponding sales designations can be found in the section "Technical data".
- Directional data, e.g. left or right, or front or back, always relate to the direction of travel.
- The vehicle display screens may not support your specific language.
- In this manual all display messages and interior labellings are written in **bold** type.

## Danger, Warnings and Cautions

### **Danger**

Text marked **△ Danger** provides information on risk of fatal injury. Disregarding this information may endanger life.



### **Warning**

Text marked **△ Warning** provides information on risk of accident or injury. Disregarding this information may lead to injury.

### **Caution**

Text marked **Caution** provides information on possible damage to the vehicle. Disregarding this information may lead to vehicle damage.

## Symbols

Page references are indicated with .  means "see page".

Thank you for choosing a Vauxhall.

We wish you many hours of pleasurable driving.

**Adam Opel GmbH**  
**Your Vauxhall Team**



## In brief

## Initial drive information

### Vehicle unlocking

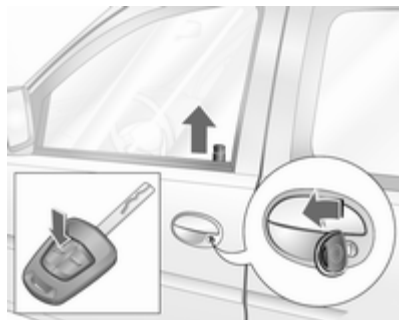

Turn the key in the driver's door lock to the front or press button  $\supseteq$  to unlock the doors. Open the doors by pulling the handles.

To unlock the leaf doors, turn the key to the vertical position or press button  $\supseteq$ . The radio remote control will only unlock the leaf doors if the key slot is in vertical position.

To open the right leaf door pull the handle. To open the left leaf door, turn the handle on the inside.

### Unlocking the tailgate



To unlock the tailgate, turn the key to the horizontal position or press button  $\supseteq$ . The radio remote control will only unlock the tailgate if the key slot is in horizontal position.

To open the tailgate press the button.

Radio remote control  $\diamond$  18, Central locking system  $\diamond$  19, Sliding doors  $\diamond$  23, Load compartment  $\diamond$  24.

## Seat adjustment

### Seat positioning

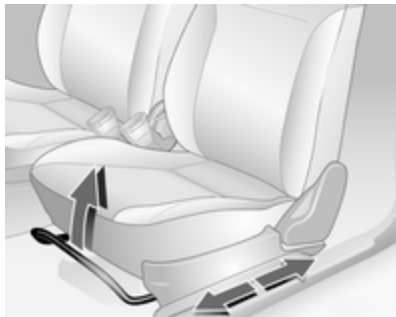

Pull handle, slide seat, release handle. Move the seat until it engages.

Seat adjustment ⇨ 35, Seat position ⇨ 34.

### **⚠ Danger**

Do not sit nearer than 25 cm from the steering wheel, to permit safe airbag deployment.

### Seat backrests



Turn handwheel. Do not lean on seat when adjusting.

Seat adjustment ⇨ 35, Seat position ⇨ 34, Folding front passenger seat backrest ⇨ 36.

### Seat height

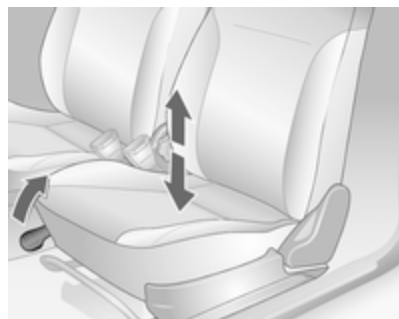

Lift lever and relieve some weight from seat to raise it or press down on seat with body weight to lower it.  
Seats ⇨ 35, Seat position ⇨ 34.

## Head restraint adjustment



Tilt forward to release, hold in place, adjust height and release again.

Head restraints ⇨ 33.

## Seat belt



Pull out the seat belt and engage in belt buckle. The seat belt must not be twisted and must fit close against the body. The backrest must not be tilted back too far (maximum approx. 25 °).

To release belt, press red button on belt buckle.

Seat belts ⇨ 37, Airbag system ⇨ 39, Seat position ⇨ 34.

## Mirror adjustment

### Interior mirror



Swivel the lever on the underside to reduce dazzle.

Interior mirror ⇨ 30.



## Exterior mirrors

### Manual adjustment



Adjust the exterior mirror manually using the handle.

### Electric adjustment

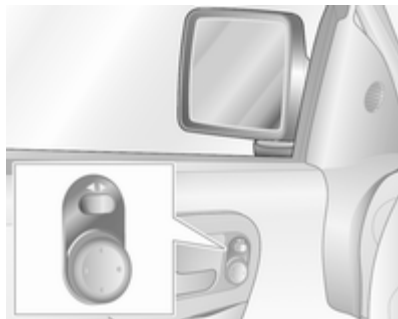

First select the relevant exterior mirror with the rocker switch and adjust with the four-way switch.

Electric adjustment ⇨ 29, Convex exterior mirrors ⇨ 29, Folding exterior mirrors ⇨ 29, Heated exterior mirrors ⇨ 30.

## Steering wheel adjustment

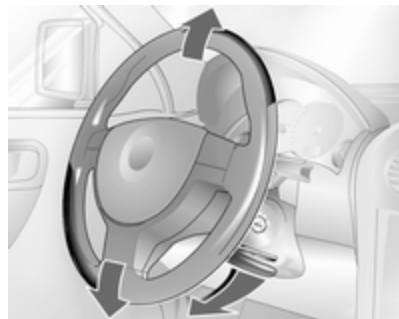

Unlock lever, adjust height, then engage lever and ensure it is fully locked. Do not adjust steering wheel unless vehicle is stationary and steering wheel lock has been released.

Airbag system ⇨ 39, Ignition positions ⇨ 85.

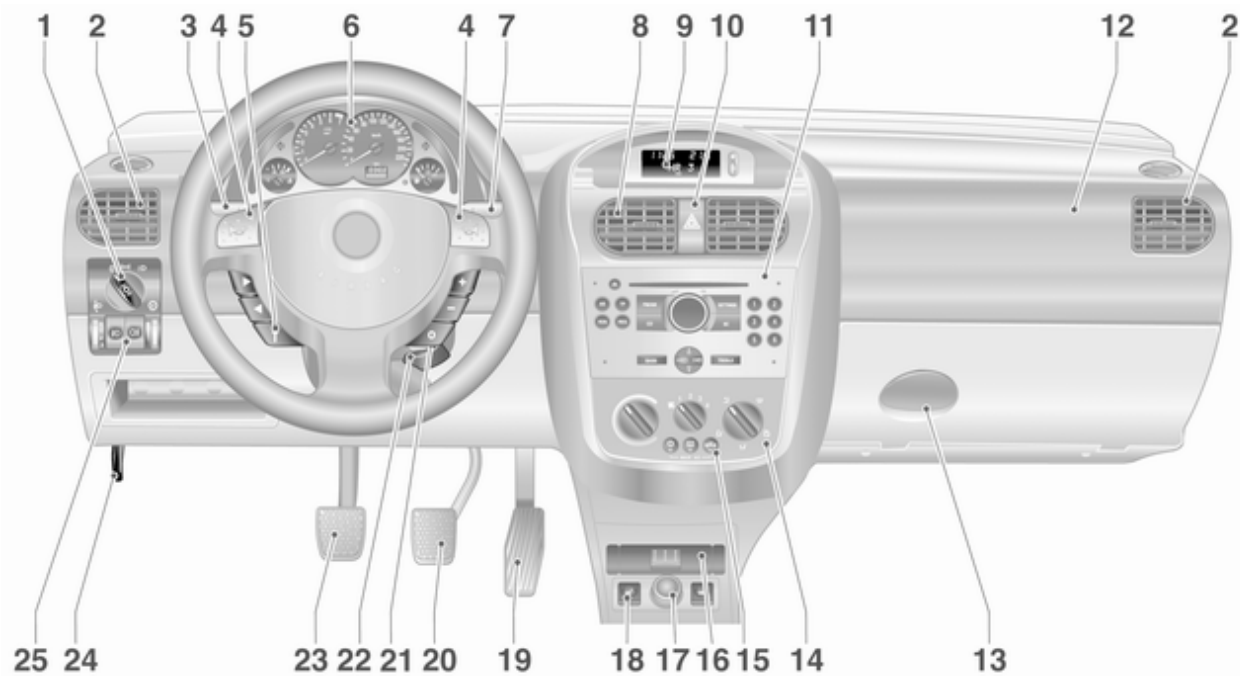

## Instrument panel overview

|    |   |     |
|----|---|-----|
| 1  | Light switch .....  | 75  |
| 2  | Side air vents .....  | 82  |
| 3  | Turn and lane-change signals, headlight flash, low beam and high beam ..... | 77  |
| 4  | Horn .....  | 57  |
| 5  | Steering wheel controls .....   | 56  |
| 6  | Instruments .....   | 61  |
| 7  | Windscreen wiper, windscreen washer system ...                              | 57  |
| 8  | Centre air vents .....  | 82  |
| 9  | Info-Display .....  | 70  |
| 10 | Hazard warning flashers .....   | 76  |
|    | LED for anti-theft alarm system .....                                       | 25  |
| 11 | Infotainment system .....   | 10  |
| 12 | Front passenger airbag .....  | 40  |
| 13 | Glovebox .....  | 47  |
| 14 | Heating and ventilation system .....  | 80  |
| 15 | Air conditioning system .....   | 81  |
|    | Heated rear window .....  | 32  |
| 16 | Ashtray .....   | 60  |
| 17 | Cigarette lighter .....   | 59  |
|    | Power outlet .....  | 59  |
| 18 | Seat heating .....  | 36  |
|    | Fuel selection switch (natural gas/petrol) .....                            | 63  |
| 19 | Accelerator pedal .....   | 84  |
| 20 | Brake pedal .....   | 92  |
| 21 | Ignition switch with steering wheel lock .....                              | 85  |
| 22 | Steering wheel adjustment ...   | 56  |
| 23 | Clutch pedal .....  | 84  |
| 24 | Bonnet release lever .....  | 100 |
| 25 | Headlamp range adjustment .....   | 76  |
|    | Front fog lights .....  | 77  |
|    | Rear fog light .....  | 77  |
|    | Instrument illumination .....   | 78  |

## Exterior lighting



Turn light switch

**O** = Off

**≡** = Sidelights

**D** = Headlights

Press light switch

**☼** = Courtesy lights

Push button

**#D** = Front fog lights

**Q#** = Rear fog lights

Lighting ⇨ 75.

### Headlight flash, high beam and low beam



headlight flash = pull lever  
 high beam = push lever  
 low beam = push lever again

High beam ⇨ 75, Headlight flash  
 ⇨ 75.

### Turn and lane-change signals

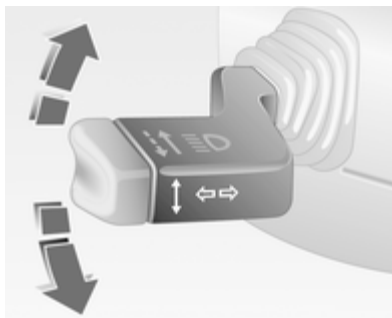

right = lever up  
 left = lever down

Turn and lane-change signals  
 ⇨ 77.

### Hazard warning flashers

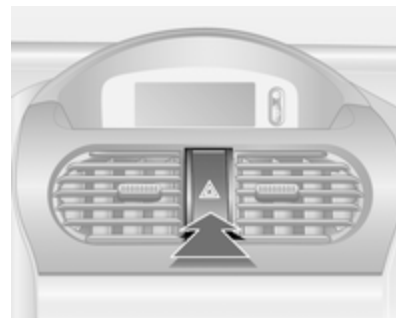

Operated with the  button.  
 Hazard warning flashers ⇨ 76.

## Horn

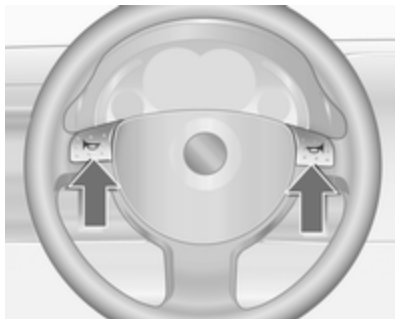

Press .

## Washer and wiper systems

### Windscreen wiper



- ≡ = fast
- = slow
- = interval wiping
- = off

Windscreen wiper ↗ 57, Wiper blade replacement ↗ 104.

### Windscreen washer systems



Pull lever.

Windscreen washer system ↗ 57,  
Washer fluid ↗ 103.

## Rear window wiper and washer system





- Wiper on = push lever
- Wiper off = pull lever
- Wash = push lever and hold

Rear window wiper and washer system ↪ 58, Wiper blade replacement ↪ 104, Washer fluid ↪ 103.

## Climate control

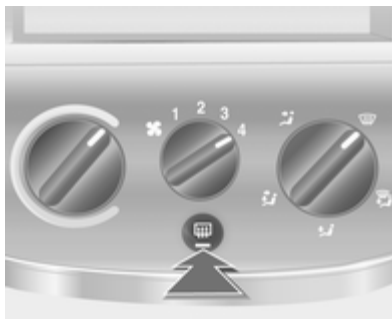
### Heated rear window, heated exterior mirrors



Heating is operated by pressing the  button.

Heated rear window ↪ 32.

## Demisting and defrosting the windows

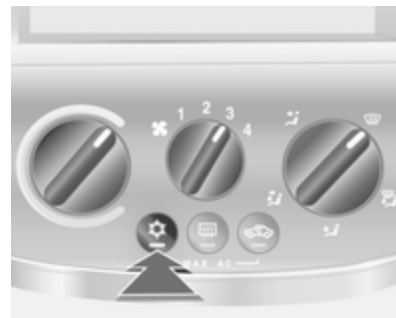

Set temperature control to warmest level.

Set fan speed to highest level.

Set air distribution to .

Cooling  on.

Climate control system ↪ 80.

## Transmission

### Manual transmission



Reverse: with the vehicle stationary, wait 3 seconds after depressing clutch pedal and then lift the ring under the selector lever and engage the gear.

If the gear does not engage, set the lever to neutral, release the clutch pedal and depress again; then repeat gear selection.

Manual transmission ⇨ 88.

### Manual transmission automated

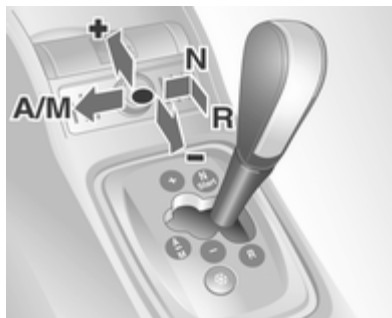

- N** = neutral position
- = drive position
- +** = higher gear
- = lower gear
- A/M** = switch between automatic and manual mode
- R** = reverse gear (with selector lever lock)

To move the selector lever from **N** to **R** press the button on the lever.

Only start in **N** with foot brake applied.

Manual transmission automated ⇨ 89.

## Starting off

### Check before starting off

- Tyre pressure and condition  
⇨ 120, ⇨ 149.
- Engine oil level and fluid levels  
⇨ 101.
- All windows, mirrors, exterior lighting and number plates are free from dirt, snow and ice and are operational.
- Proper position of mirrors, seats, and seat belts ⇨ 29, ⇨ 34, ⇨ 38.
- Brake function at low speed, particularly if the brakes are wet.

## Starting the engine

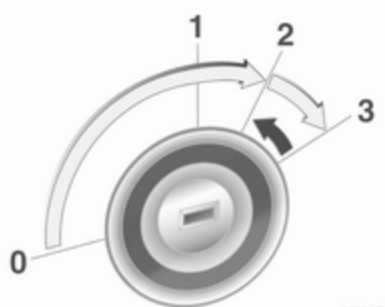

- Turn key to position 1
- move the steering wheel slightly to release the steering wheel lock
- operate clutch and brake
- manual transmission automated in **N**
- do not operate accelerator pedal
- diesel engines, turn the key to position 2 for preheating and wait until control indicator  goes out
- turn key to 3 and release

Starting the engine ⇨ 85.

## Parking

- Always apply the parking brake without pressing the release button. Apply as firmly as possible on a downhill slope or uphill slope. Depress the foot brake at the same time to reduce operating force.
- Switch off the engine. Turn the ignition key to 0 and remove it. Turn the steering wheel until the steering wheel lock is felt to engage.
- If the vehicle is on a level surface or uphill slope, engage first gear or move the selector lever to centre position before switching off the ignition. On an uphill slope, turn the front wheels away from the kerb.

If the vehicle is on a downhill slope, engage reverse gear or move the selector lever to centre position before switching off the ignition. Turn the front wheels towards the kerb.

- Lock the vehicle with button  on the radio remote control.

Activate the anti-theft alarm system ⇨ 25.

- Do not park the vehicle on an easily ignitable surface. The high temperature of the exhaust system could ignite the surface.
- Close windows and sunroof.
- The engine cooling fans may run after the engine has been switched off ⇨ 100.
- After running at high engine speeds or with high engine loads, operate the engine briefly at a low load or run in neutral for approx. 30 seconds before switching off, in order to protect the turbocharger.

Keys, locks ⇨ 17,

Laying the vehicle up for a long period of time ⇨ 99.



## Keys, doors and windows

|                        |    |
|------------------------|----|
| Keys, locks .....      | 17 |
| Doors .....            | 23 |
| Vehicle security ..... | 25 |
| Exterior mirrors ..... | 29 |
| Interior mirrors ..... | 30 |
| Windows .....          | 30 |

## Keys, locks

### Keys

#### Replacement keys

The key number is specified in the Car Pass or on a detachable tag.

The key number must be quoted when ordering replacement keys as it is a component of the immobiliser system.

Locks ⇨ 132.

#### Lock cylinders

Designed to free-wheel if they are forcefully rotated without the correct key or if the correct key is not fully inserted. To reset, turn cylinder with the correct key until its slot is vertical, remove key and then re-insert it. If the cylinder still free-wheels, turn the key through 180° and repeat operation.

## Key with foldaway key section



Press button to extend. To fold the key, first press the button.

## Car Pass

The Car Pass contains security related vehicle data and should therefore be kept in a safe place.

When the car is taken to a workshop, this vehicle data is needed in order to perform certain operations.

## Radio remote control



Used to operate:

- Central locking system,
- Anti-theft locking system,
- Anti-theft alarm system,
- Power windows.

The radio remote control has an approximate range of up to 16 ft. This range can be affected by outside influences. The hazard warning flashers confirm operation.

The radio remote control has an approximate range of up to 5 metres. This range can be affected by outside influences. The hazard warning flashers confirm operation.

Handle with care, protect from moisture and high temperatures and avoid unnecessary operation.

### Fault

If the central locking system cannot be operated with the radio remote control, it may be due to the following:

- Range exceeded,
- Battery voltage too low,
- Frequent, repeated operation of the radio remote control while not in range, which will require re-synchronisation,
- Overload of the central locking system by operating at frequent intervals, the power supply is interrupted for a short time,
- Interference from higher-power radio waves from other sources.

Unlocking ⇨ 19.

## Radio remote control battery replacement

Replace the battery as soon as the range is noticeably diminished.



Batteries do not belong in household waste. They must be disposed of at an appropriate recycling collection point.

### Key with foldaway key section

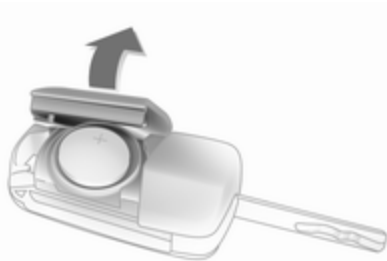

Extend the key and open the unit. Replace the battery (battery type CR 2032), paying attention to the installation position. Close the unit and synchronise.

### Key with fixed key section

Have the battery replaced by a workshop.

### Radio remote control synchronisation

After replacing the battery, unlock the door with the key in the driver's door lock. The radio remote control will be synchronised when you switch on the ignition.

### Central locking system

Unlocks and locks doors, load compartment and fuel filler flap.

#### Note

In the event of an accident of a certain severity, the vehicle unlocks automatically.

#### Note

A short time after unlocking with the remote control the doors are locked automatically if no door has been opened.

### Unlocking

#### Central locking system with key activation



Turn the key in the driver's door lock to the front.



### Central locking system with radio remote control



Press button .

Two settings are possible:

To unlock only the vehicle, press button .

Country-specific version: Pressing the button  once will unlock the driver's door. Pressing the button  twice will unlock the entire vehicle.

### Locking

Close doors, load compartment and fuel filler flap. If the driver's door is not closed properly, the central locking system will not work.

### Central locking system with key activation

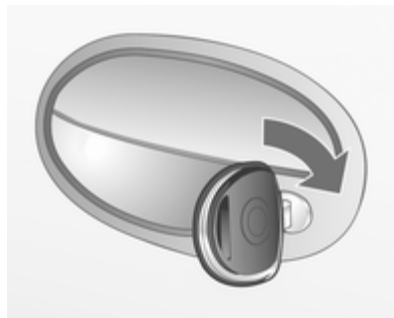

Turn the key in the driver's door lock rearwards.

### Central locking system with radio remote control



Press button .

## Fault in radio remote control



### Unlocking

Turn the key in the driver's door lock towards front of vehicle. The entire vehicle is unlocked. Switch on ignition to deactivate anti-theft alarm system.

### Locking

Close the driver's door, turn key in lock towards rear of vehicle. The vehicle is locked.

## Fault in central locking system

### Unlocking

Turn the key in the driver's door lock towards front of vehicle. The other doors can be opened by pulling the interior handle (not possible if the anti-theft locking system is active). The load compartment and fuel filler flap remain locked. To deactivate the anti-theft locking system, switch on the ignition ↗ 25.

### Locking

With the driver's door open, press the lock button of one of the other doors. Close the driver's door and turn the key in the driver's door lock toward the rear of the vehicle. The unlocked fuel filler flap cannot be locked.

### Note

- The mechanical anti-theft locking system and the anti-theft alarm system cannot be activated with the key.
- To deactivate the anti-theft alarm system alarm, switch on the ignition after opening a door.

## Central locking and the tailgate

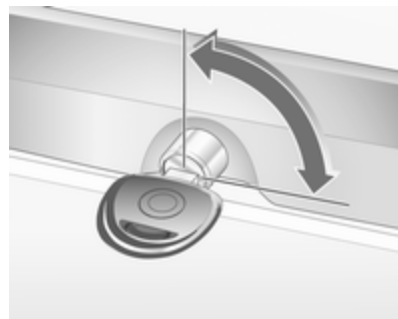

The central locking system and anti-theft locking system for the doors cannot be operated via the tailgate lock.

### Key slot horizontal in lock

When the central locking system is operated, the tailgate is locked or unlocked together with the doors.

If the key is turned to the vertical position after unlocking via the central locking system, the tailgate remains locked.

**Key slot vertical in lock**

The tailgate remains locked when the doors are locked or unlocked via the central locking system. Choose this position if the tailgate should always remain locked.

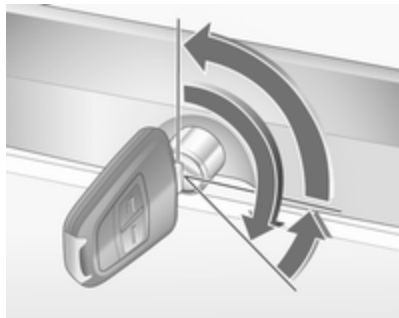
**Unlocking the tailgate with the key with centrally locked doors**

Turn the key clockwise as far as possible beyond the resistance point from the vertical or horizontal position. To safeguard against being locked out, the key cannot be removed when in this position.

Relock the tailgate by closing it and turning the key to the horizontal or vertical position.

In the horizontal position, the tailgate will be unlocked the next time the vehicle is unlocked via the central locking system.

**Central locking and the leaf doors**

The central locking system and anti-theft locking system for the doors cannot be operated via the leaf doors lock.

**Key slot horizontal in lock**

When the central locking system is operated, the leaf doors are locked or unlocked together with the doors.

If the key is turned to the vertical position after unlocking via the central locking system, the leaf doors remain locked.

**Key slot vertical in lock**

The leaf doors remain locked when the doors are locked or unlocked via the central locking system. Choose this position if the leaf doors are to always remain locked.

### Unlocking the leaf doors with the key with centrally locked doors



Turn the key anti-clockwise as far as possible beyond the resistance point from the vertical or horizontal position and pull the handle of the leaf door. To safeguard against being locked out, the key cannot be removed when in this position.

Relock the leaf doors by closing it and turning the key to the horizontal or vertical position.

In the horizontal position, the leaf doors will be unlocked the next time the vehicle is unlocked via the central locking system.

### Child locks



#### **⚠ Warning**

Use the child locks whenever children are occupying the rear seats.

Using a key or suitable screwdriver, turn the rotary knob on the door lock from the vertical position. The door cannot be opened from inside.

### Doors

#### Sliding door

#### **⚠ Warning**

If the vehicle is parked on a downhill slope, open sliding doors may move accidentally on account of their weight.

Close the sliding doors before driving off.

#### Opening from outside



To open the sliding doors, pull the handle and slide the door towards the rear of the vehicle.

### Opening from inside

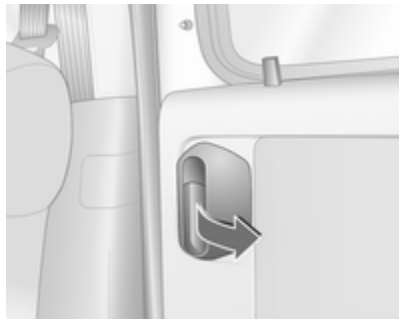

To open the unlocked sliding door, pull the handle and slide the door towards the rear of the vehicle.

To prevent damage, the right-hand sliding door cannot be fully opened if the tank flap is open.

### To close

Slide the sliding door until it engages.

## Load compartment

### Tailgate

#### Opening



Press the button to open the tailgate.

#### **⚠ Warning**

Do not drive with the tailgate open or ajar, e.g. when transporting bulky objects, since toxic exhaust gases could enter the vehicle.

### Note

The installation of certain heavy accessories onto the tailgate may affect its ability to remain open.

### Closing



Use the interior handle.

Do not press the button under the moulding while closing as this will unlock the tailgate again.



## Leaf doors



### Opening

Open right-hand leaf door from outside by raising door handle or from inside by pivoting handle.

Unlock and open the left-hand leaf door from inside by pivoting the handle.

The doors engage at a 90° position. Both doors can be opened up to 180°:

Close the door slightly from the 90° position, disengage the stop lug from the guide rail and open the door completely.

When the doors are open 180°, the rear exterior lighting is covered. Therefore, only open the doors until they engage when it is dark outside.

When closing, make sure that the stop lug properly engages in the guide rail.

### Closing



Push first the left and then the right leaf door past slight resistance.

## Vehicle security

### Anti-theft alarm system

It monitors:

- Doors, load compartment, bonnet,
- Passenger compartment,
- Vehicle inclination, e.g. if it is raised,
- Ignition.

#### **Warning**

Do not use the system if there are people in the vehicle! The doors cannot be unlocked from the inside.

#### **Note**

Changes to the vehicle interior, such as the use of seat covers, could impair the function of passenger compartment monitoring.

### Activating with the radio remote control

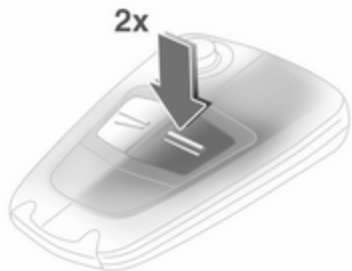

All doors, windows and the bonnet must be closed.

Press **⏏** twice within 10 seconds.

If the ignition was on, the driver's door must be opened and closed in order to activate the anti-theft alarm system.

### Activating with the radio remote control



All doors, windows and the bonnet must be closed.

Press button **⏏** on the radio remote control.

If the ignition was on, the driver's door must be opened and closed in order to activate the anti-theft alarm system.

### Activation without monitoring of passenger compartment and vehicle inclination



Switch off the monitoring of passenger compartment and vehicle inclination when animals are being left in the vehicle, because of high volume ultrasonic signals or movements triggering the alarm. Switch off as well when the vehicle is on a ferry or train or if the interior of the parked vehicle is being heated.

1. Close load compartment and bonnet.

2. Press button in front of the courtesy light (with ignition off); LED in the hazard warning flashers button flashes for a maximum of 10 seconds.
3. Close doors.
4. Activate the anti-theft alarm system. The LED illuminates. After approx. 10 seconds, the system is armed. The LED flashes until the system is deactivated.

### Light-emitting diode (LED)

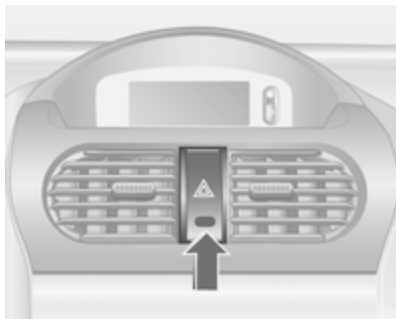

During the first 10 seconds of anti-theft alarm system activation:

LED illuminates = Test, ignition delay,  
LED flashes quickly = Door, load compartment or bonnet open, or system fault.

After the first 10 seconds of anti-theft alarm system activation:

LED flashes slowly = System active.  
LED illuminates for approx. 1 second = System deactivated.

Seek the assistance of a workshop in the event of faults.

### Deactivation

Press button  on radio remote control or switch on ignition.

If there is a fault in remote control, turn key in driver's door lock toward front of vehicle as far as it will go.

If the alarm is triggered when the driver's door is opened, deactivate the anti-theft alarm system by switching on the ignition.

### Opening and closing tailgate/leaf doors with activated anti-theft alarm system

To unlock:

1. Tailgate:

Turn key clockwise all the way past the horizontal position. The tailgate is unlocked and monitoring of the passenger compartment and vehicle inclination are disabled.

Leaf doors:

Turn key anti-clockwise all the way past the vertical position. The leaf doors are unlocked and monitoring of the passenger compartment and vehicle inclination are disabled.

2. Open the tailgate or leaf doors.
3. Close the tailgate or leaf doors.

4. To lock: Turn key back to horizontal or vertical position. Monitoring of the interior and vehicle inclination is enabled after approx. 10 seconds.

## Alarm

When triggered, the alarm gives off an acoustic signal (horn) and a visual signal (hazard warning flashers). The number and duration of which are stipulated by legislation.

The alarm siren can be silenced by pressing any button of the radio remote control or by switching on the ignition. The anti-theft alarm system is deactivated at the same time.

If the vehicle's battery is to be disconnected (e.g. for maintenance work), the alarm siren must be deactivated as follows: switch the ignition on then off, then disconnect the vehicle's battery within 15 seconds.

## Immobiliser

The system checks whether the vehicle is allowed to start with the key being used. If the transponder in the key is recognised, the engine can be started.

The immobiliser activates itself automatically after the key has been removed from the ignition switch.

If the control indicator  flashes when the ignition is on, there is a fault in the system; the engine cannot be started. Switch off the ignition and then repeat the start attempt.

If the control indicator  continues flashing, attempt to start the engine using the spare key and seek the assistance of a workshop.

If control indicator illuminates after the engine has started, there is a fault in the engine electronics or transmission electronics ⇨ 67, ⇨ 91, or there is water in the diesel fuel filter.

## Note

The immobiliser does not lock the doors. You should always lock the vehicle after leaving it and switch on the anti-theft alarm system ⇨ 19, ⇨ 25.

## Exterior mirrors

### Convex shape

The convex exterior mirror reduces blind spots. The shape of the mirror makes objects appear smaller, which will affect the ability to estimate distances.

### Manual adjustment



Adjust mirrors by swivelling lever in required direction.

### Electric adjustment

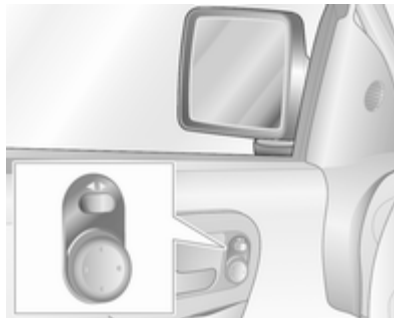

Select the relevant exterior mirror with the rocker switch and adjust with the four-way switch.

### Folding

#### Manual





For pedestrian safety, the exterior mirrors will swing out of their normal mounting position if they are struck with sufficient force. Reposition the mirror by applying slight pressure to the mirror housing.

The exterior mirrors can be folded in by pressing gently on the outer edge of the housing.

Return the mirrors to the driving position before starting off.

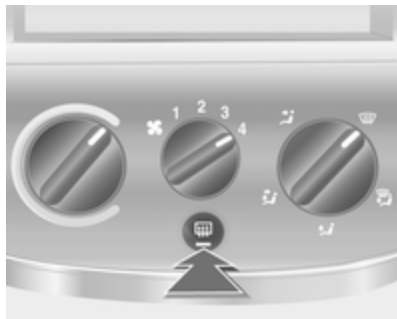
## Heated



Operated by pressing the  button. Heating works with the engine running.

## Interior mirrors

### Manual anti-dazzle



To reduce dazzle, adjust the lever on the underside of the mirror housing.

## Windows

### Manual windows

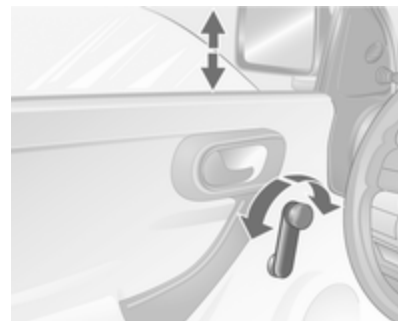

The door windows can be opened or closed with the window winders.

## Window in the sliding doors

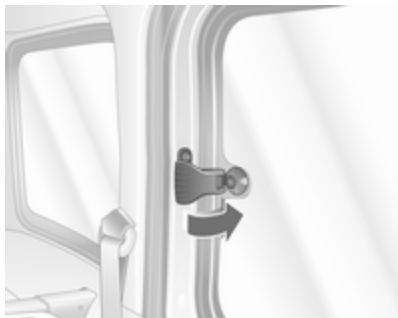

To open = Release joint and push outwards.

To close = Pull joint and engage.

## Power windows

### ⚠ Warning

Take care when operating the power windows. Risk of injury, particularly to children.

Keep a close watch on the windows when closing them. Ensure that nothing becomes trapped in them as they move.

Power windows can be operated when the ignition key is in position 1 in the ignition switch.

Illumination of the rocker switches indicates operational readiness.

After switching off the ignition, the window operation is disabled, when the driver's door is opened.

## Operation

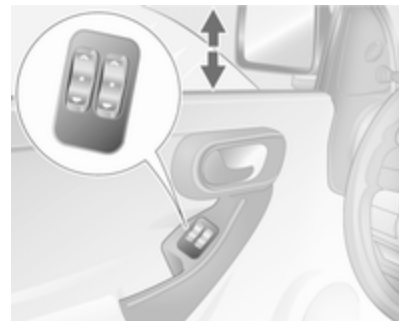

To operate the window in stages, tap the rocker switch. For automatic opening or closing, hold the switch pressed for slightly longer; to stop window movement, tap rocker switch again.

### Safety function

If the window glass encounters resistance during automatic closing, it is immediately stopped and opened again.

In the event of closing difficulties due to frost or the like, operate the switch several times to close the window in stages.

### Operating windows from outside

Depending on the equipment level, the windows can be operated remotely from outside the vehicle.

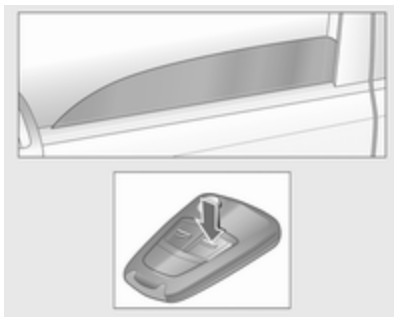

Press  until all windows are closed.

### Overload

If the windows are repeatedly operated at short intervals, the window operation is disabled for some time.

### Fault

If the windows cannot be opened or closed automatically, activate the window electronics as follows:

1. Close doors.
2. Switch on ignition.
3. Close the window completely and operate the button for 5 more seconds.
4. Open the window completely and operate the button for 1 more second.
5. Repeat this for each window.

### Heated rear window

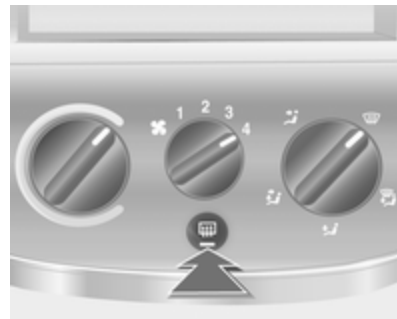

Operated by pressing the  button.

Heating functions with the engine running and is switched off automatically after a short time.

Depending on the engine type, the heated rear window comes on automatically when the diesel particle filter is being cleaned.

### Sun visors

The sun visors can be folded down or swivelled to the side to prevent dazzling.



## Seats, restraints

|                        |    |
|------------------------|----|
| Head restraints .....  | 33 |
| Front seats .....      | 34 |
| Seat belts .....       | 37 |
| Airbag system .....    | 39 |
| Child restraints ..... | 41 |

## Head restraints

### Position

#### ⚠ Warning

Only drive with the head restraint set to the proper position.

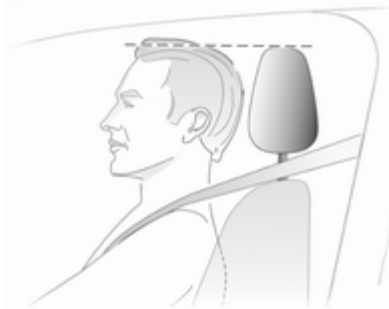

The middle of the head restraint should be at eye level. If this is not possible for extremely tall people, set to highest position, and set to lowest position for small people.

## Adjustment

### Head restraints on front and outer rear seats



To adjust, hold head restraint at side, tilt forward, hold and adjust height.

The open frame head restraint on the Combo Van cannot be adjusted.

#### Note

Approved accessories may only be attached to the front passenger seat head restraint if the seat is not in use.

### Head restraints on centre rear seats

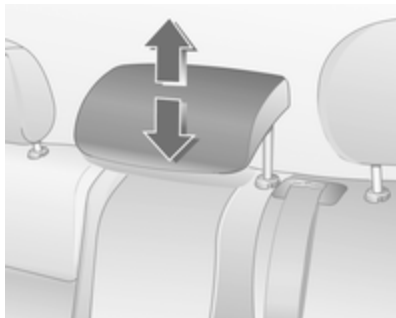

To fold the backrest, press the detent springs on the guide sleeves to release the head restraint and push it all the way down.

### Removing head restraint



Release both catches by pressing and withdraw head restraint. The rear centre head restraint cannot be removed.

## Front seats

### Seat position

#### Warning

Only drive with the seat correctly adjusted.



- Sit with buttocks as far back against the backrest as possible. Adjust the distance between the seat and the pedals so that legs are slightly angled when pressing the pedals. Slide the front passenger seat as far back as possible.

- Sit with shoulders as far back against the backrest as possible. Set the backrest to an angle so that it is possible to reach the steering wheel with arms slightly bent. Maintain contact between shoulders and the backrest when turning the steering wheel. Do not tilt the backrest too far back. We recommend a maximum angle of approx. 25°.
- Adjust the steering wheel ⇨ 56.
- Set the seat high enough to have a clear field of vision on all sides and on all display instruments. There should be at least one hand of clearance between head and the roof frame. Thighs should rest lightly on the seat without pressing into it.
- Adjust the head restraint ⇨ 33.
- Adjust the height of the seat belt ⇨ 38.

## Seat adjustment

### ⚠ Danger

Do not sit nearer than 25 cm from the steering wheel, to permit safe airbag deployment.

### ⚠ Warning

Never adjust seats while driving as they could move uncontrollably.

## Seat positioning

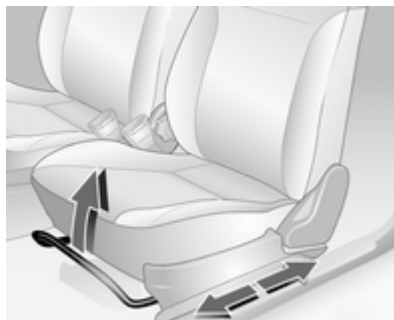

Pull handle, slide seat, release handle.

## Seat backrests

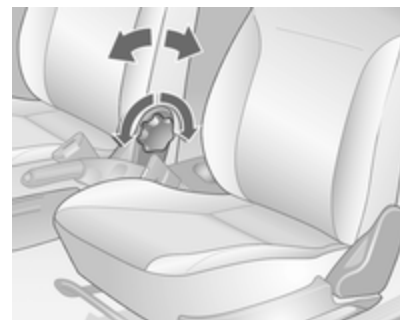

Turn handwheel. Do not lean on backrest when adjusting.

### Seat height

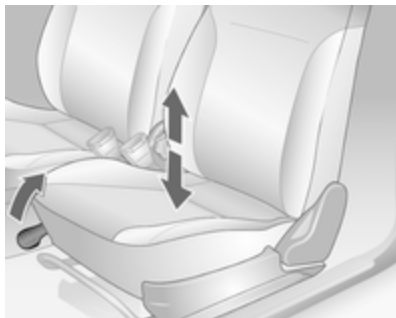

Lift lever and relieve some weight from seat to raise it or press down on seat with body weight to lower it.

### Seat folding

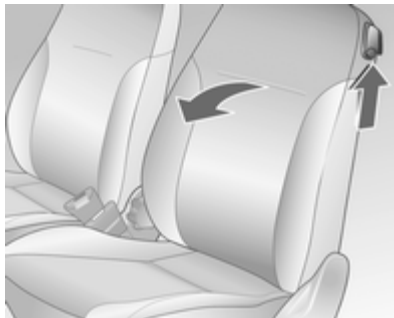

Lift release lever and tilt backrest forwards.

### Heating



Activate heating by pressing  button for the seat with the ignition on.

LED in button  on: relevant front seat heating on.

Seat heating is operational when the engine is running.

For vehicles with natural gas operation, only switch  is available. Operation for both front seats when the ignition is on.

## Seat belts



The belts are locked during heavy acceleration or deceleration of the vehicle for the safety of the occupants.

### Warning

Fasten seat belt before each trip. In the event of an accident, people not wearing seat belts endanger their fellow occupants and themselves.

Seat belts are designed to be used by only one person at a time. They are not suitable for people younger than 12 years of age or smaller than 5 ft. Child restraint system ⇨ 41.

Seat belts are designed to be used by only one person at a time. They are not suitable for people younger than 12 years of age or smaller than 150 cm. Child restraint system ⇨ 41.

Periodically check all parts of the belt system for damage and proper functionality.

Have damaged components replaced. After an accident, have the belts and triggered belt tensioners replaced by a workshop.

### Note

Make sure that the belts are not damaged by shoes or sharp-edged objects or trapped. Prevent dirt from getting into the belt retractors.

## Belt tensioners

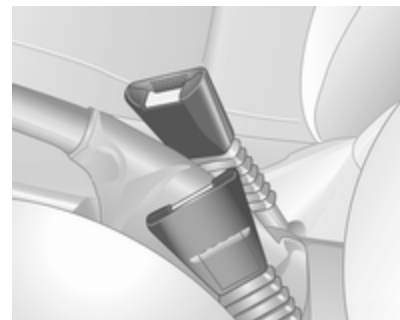

In the event of a head-on or rear-end collision of a certain severity, the front seat belts are tightened.

### Warning

Incorrect handling (e.g. removal or fitting of belts) can trigger the belt tensioners with risk of injury.

Deployment of the belt tensioners is indicated by illumination of control indicator  ⇨ 67.

Triggered belt tensioners must be replaced by a workshop. Belt tensioners can only be triggered once.

### Note

Do not affix or install accessories or other objects that may interfere with the operation of the belt tensioners. Do not make any modifications to belt tensioner components as this will invalidate the vehicle type approval.

## Three-point seat belt

### Fitting

Withdraw belt from retractor, guide it untwisted across the body and insert the latch plate in the buckle. Tension the lap belt regularly whilst driving by tugging the shoulder belt.

Loose or bulky clothing prevents the belt from fitting snugly. Do not place objects such as handbags or mobile phones between the belt and your body.

### Warning

The belt must not rest against hard or fragile objects in the pockets of your clothing.

### Height adjustment



1. Pull belt out slightly.
2. Press belt guide or, in 5-door saloon, push button down.  
Press belt guide or, in 5-door passenger vehicle, push button down.
3. Adjust height and engage audibly.

Adjust the height so that the belt lies across the shoulder. It must not lie across the throat or upper arm. Do not adjust while driving.

### Removing

To release belt, press red button on belt buckle.

### Using the seat belt while pregnant



**⚠ Warning**

The lap belt must be positioned as low as possible across the pelvis to prevent pressure on the abdomen.

## Airbag system

The airbag system consists of a number of individual systems.

When triggered the airbags inflate within milliseconds. They also deflate so quickly that it is often unnoticeable during the collision.

**⚠ Warning**

If handled improperly the airbag systems can be triggered in an explosive manner.

**Note**

The airbag systems and belt pretensioner control electronics are located in the centre console area. Do not put any magnetic objects in this area.

Do not stick anything on the airbag covers and do not cover them with other materials.

Each airbag is triggered only once. Have deployed airbags replaced by a workshop. Furthermore, it might be necessary to have the steering wheel, the instrument panel, parts of the panelling, the door seals, handles and the seats replaced.

Do not make any modifications to the airbag system as this will invalidate the vehicle type approval.

When the airbags inflate, escaping hot gases may cause burns.

Control indicator  for airbag systems  
↪ 67.

## Front airbag system



The front airbag system consists of one airbag in the steering wheel and one in the instrument panel on the front passenger side. These can be identified by the word **AIRBAG**.

The front airbag system is triggered in the event of an accident of a certain severity in the depicted area. The ignition must be on.

The forward movement of the front seat occupants is decelerated, thereby considerably reducing the risk of injury to the upper body and head.

### ⚠ Warning

Optimum protection is only provided when the seat is in the proper position ↪ 34.

Keep the area in which the airbag inflates clear of obstructions.

Fit the seat belt correctly and engage securely. Only then the airbag is able to protect.

## Side airbag system

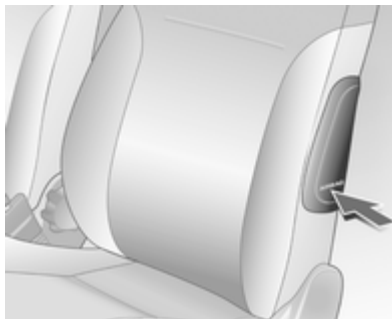

### ⚠ Warning

Keep the area in which the airbag inflates clear of obstructions.

### Note

Only use protective seat covers that have been approved for the vehicle. Be careful not to cover the airbags.

The side airbag system consists of an airbag in each front seat backrest and in the rear outboard seat backrests. This can be identified by the word **AIRBAG**.

The side airbag system is triggered in the event of an accident of a certain severity in the depicted area. The ignition must be on.

The risk of injury to the upper body and pelvis in the event of a side-on collision is considerably reduced.



## Child restraints

### Child restraint systems

When a child restraint system is being used, pay attention to the following usage and installation instructions and also those supplied with the child restraint system.

Always comply with local or national regulations. In some countries, the use of child restraint systems is forbidden on certain seats.

#### Warning

When using a child restraint system on the front passenger seat, the airbag systems for the front passenger seat must be deactivated; if not, the triggering of the airbags poses a risk of fatal injury to the child.

This is especially the case if rear-facing child restraint systems are used on the front passenger seat.

### Selecting the right system

The rear seats are the most convenient location to fasten a child restraint system. Children should travel facing rearwards in the vehicle as long as possible. This makes sure that the child's backbone, which is still very weak, is under less strain in the event of an accident.

Children under the age of 12 years that are smaller than 5 ft are only allowed to travel in a restraint system that is suitable for the child. Suitable are restraint systems that comply with ECE 44-03 or ECE 44-04. Since a proper position of the belt is rarely possible with a child that is smaller than 5 ft, we strongly advise to use an appropriate child restraint system, even though this might, due to the age of the child, no longer be legally binding.

Children under the age of 12 years that are smaller than 150 cm are only allowed to travel in a restraint system that is suitable for the child. Suitable are restraint systems that comply with ECE 44-03 or ECE 44-04. Since

a proper position of the belt is rarely possible with a child that is smaller than 150 cm, we strongly advise to use an appropriate child restraint system, even though this might, due to the age of the child, no longer be legally binding.

Never hold a child whilst travelling in the vehicle. The child will become too heavy to be held in the event of a collision.

When transporting children, use the child restraint systems suitable for the child's weight.

Ensure that the child restraint system to be installed is compatible with the vehicle type.

Ensure that the mounting location of the child restraint system within the vehicle is correct.

Only allow children to enter and exit the vehicle at the side facing away from the traffic.

When the child restraint system is not in use, secure the seat with a seat belt or remove it from the vehicle.

**Note**

Do not stick anything on the child restraint systems and do not cover them with any other materials.

A child restraint system which has been subjected to stress in an accident must be replaced.

## Child restraint installation locations

### Permissible options for fitting a child restraint system

| Weight and age class   | On front passenger seat | On rear outboard seats | On rear centre seat |
|--|-------------------------|------------------------|---------------------|
| <b>Group 0: up to 10 kg</b><br>or approx. 10 months          | X                       | U+                     | U                   |
| <b>Group 0+: up to 13 kg</b><br>or approx. 2 years           | X                       | U+                     | U                   |
| <b>Group I: 9 to 18 kg</b><br>or approx. 8 months to 4 years | X                       | U+                     | U                   |
| <b>Group II: 15 to 25 kg</b><br>or approx. 3 to 7 years      | X                       | U                      | U                   |
| <b>Group III: 22 to 36 kg</b><br>or approx. 6 to 12 years    | X                       | U                      | U                   |

+ = Vehicle seat with ISOFIX mounting available. Only the ISOFIX child restraint systems that are approved for the vehicle must be used when mounting with ISOFIX.

U = Universal suitability in conjunction with three-point seat belt.

X = No child restraint system permitted in this weight class.

---

**Permissible options for fitting an ISOFIX child restraint system**

| Weight class                 | Size class | Fixture | On front passenger seat | On rear outboard seats | On rear centre seat |
|------------------------------|------------|---------|-------------------------|------------------------|---------------------|
| <b>Group 0: up to 10 kg</b>  | E          | ISO/R1  | X                       | IL                     | X                   |
| <b>Group 0+: up to 13 kg</b> | E          | ISO/R1  | X                       | IL                     | X                   |
|                              | D          | ISO/R2  | X                       | IL                     | X                   |
|                              | C          | ISO/R3  | X                       | IL                     | X                   |
| <b>Group I: 9 to 18 kg</b>   | D          | ISO/R2  | X                       | IL                     | X                   |
|                              | C          | ISO/R3  | X                       | IL                     | X                   |
|                              | B          | ISO/F2  | X                       | IL                     | X                   |
|                              | B1         | ISO/F2X | X                       | IL                     | X                   |
|                              | A          | ISO/F3  | X                       | IL                     | X                   |

---

IL = Suitable for particular ISOFIX restraint systems of the 'specific-vehicle', 'restricted' or 'semi-universal' categories. The ISOFIX restraint system must be approved for the specific vehicle type.

Opel does offer those Child Restraint Systems.

Vauxhall does offer those Child Restraint Systems

X = No ISOFIX child restraint system approved in this weight class.

---

**ISOFIX size class and seat device**

- A – ISO/F3 = Forward-facing child restraint system for children of maximum size in the weight class 9 to 18 kg.
- B – ISO/F2 = Forward-facing child restraint system for smaller children in the weight class 9 to 18 kg.
- B1 – ISO/F2X = Forward-facing child restraint system for smaller children in the weight class 9 to 18 kg.
- C – ISO/R3 = Rear-facing child restraint system for children of maximum size in the weight class up to 13 kg.
- D – ISO/R2 = Rear-facing child restraint system for smaller children in the weight class up to 13 kg.
- E – ISO/R1 = Rear-facing child restraint system for young children in the weight class up to 13 kg.

## **Isofix child restraint systems**

The mounting eyes for the ISOFIX child restraint system are located on the rear, outer seats between the seat back and the seat cushion.

Fasten permitted ISOFIX child restraint systems to the mounting brackets.

Closely follow the installation instructions accompanying the ISOFIX child restraint system.

## Storage

|                            |    |
|----------------------------|----|
| Storage compartments ..... | 47 |
| Load compartment .....     | 49 |
| Roof rack system .....     | 54 |
| Loading information .....  | 54 |

## Storage compartments

### Glovebox

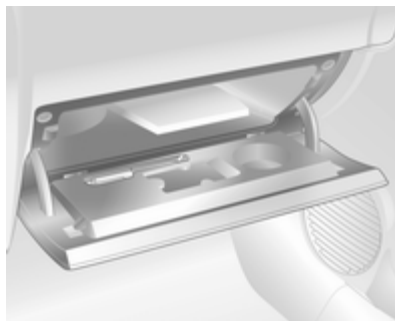

The glovebox features a pen holder.

In vehicles with Infotainment system, the telematics unit can be located in the glovebox.

The glovebox should be closed whilst driving.

## Sunglasses storage

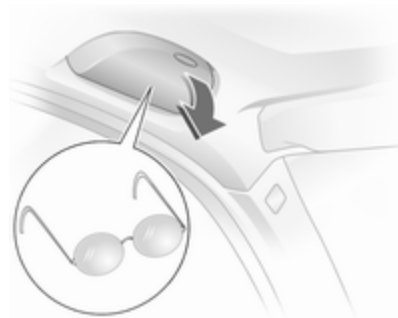

Fold down and open.

Do not use for storing heavy objects.

## Overhead console

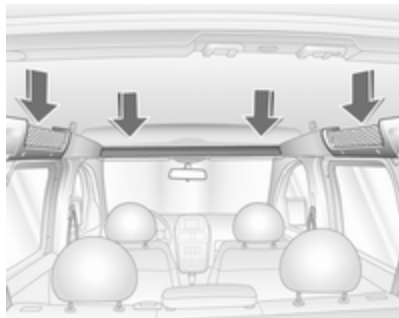

The stowage compartment above the front seats can hold a maximum load of 15 kg.

The mesh packets above the doors can only hold light objects.

### **⚠ Warning**

Secure objects to prevent them from falling out and causing injury.

## Underseat storage

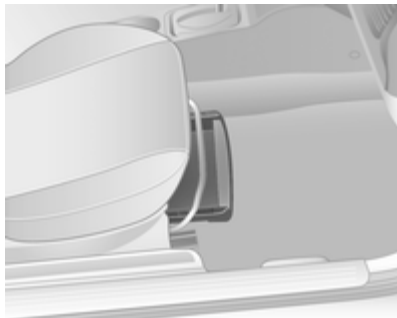

Lift at recessed edge and pull out. Maximum load: 1 kg. To close, push in and engage.

## Centre console storage

### Coin holder



Located in the centre console.



## Load compartment

### Folding down rear backrests



Push the rear, outer head restraint down completely or remove it. Push the rear, centre head restraint down completely ↻ 33.

To fold one or both of the rear seat backrests, press the button at the top to release the backrest and fold it onto the seat cushion.

Alternatively:

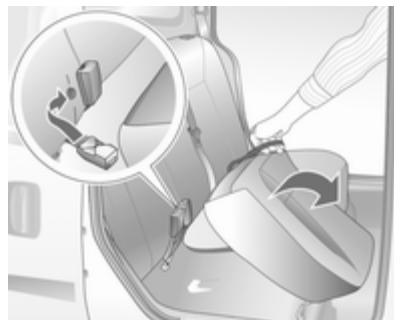

Remove the rear, outer head restraints. Push the rear, centre head restraint down completely ↻ 33.

Hook seat belt buckles on rear seat backrests.

Pull up one or both rear seat cushions using the straps provided.

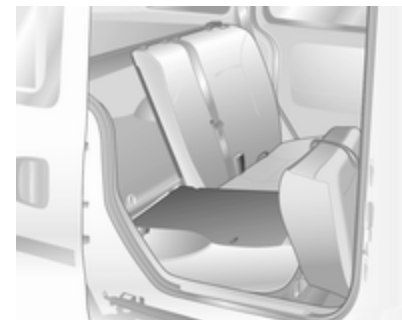

To fold one or both of the rear seat backrests, press the button at the top to release the backrest and fold it forward.

### Repositioning the rear seats

Pull the seat belt slightly forward so that it does not get damaged and audibly engage the backrests.

Reposition the seat cushions.

Insert outer rear head restraints.

### Load compartment cover

Do not place any objects on the cover.

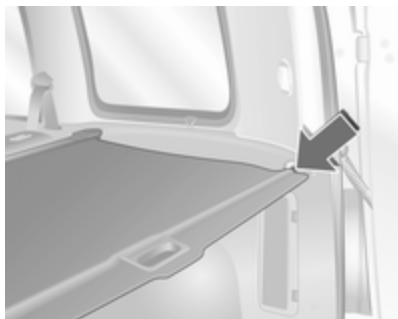
**To close**

Pull cover towards rear of vehicle using handle and hook into side retainers.

**To open**

Unhooked the closed cover at the rear. It rolls up automatically.

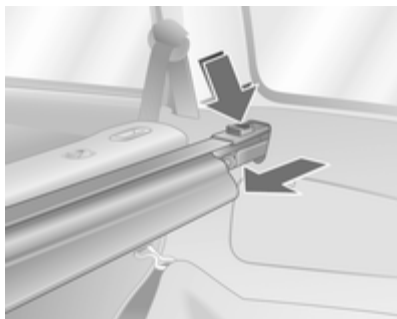
**Removing**

Open cover.

Press button at right side of cartridge and engage by pushing right-hand end piece to the left. Pull right side of cartridge out of retainers, followed by left side.

**Fitting**

With cover rolled up, push the left side of the cartridge into the retainer, followed by the right side.

Push button at right end piece of cartridge, and cartridge engages.

**Safety net**

The safety net can be installed behind the rear seats or, if the rear seat backrests are folded down, behind the front seats.

Passengers must not be transported behind the safety net.

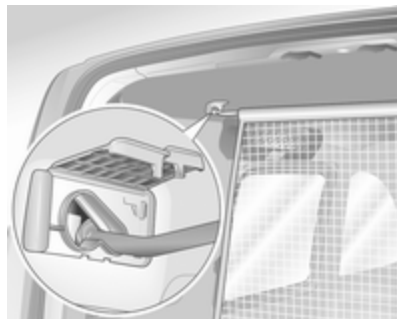
**Installation**

There are two installation openings in the roof frame: Open the cover. Engage one side of the upper net rod in one side, extend the rod and engage in the other side. Close the cover.

### Behind the rear seats

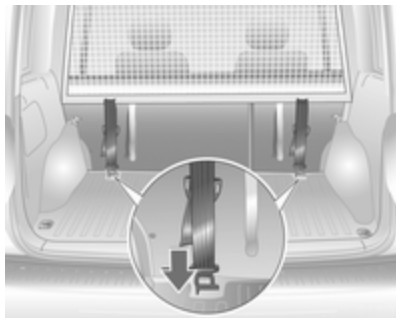

Fold down both rear seat backrests. Hook tensioning straps into lashing eyes in floor and tighten by pulling on the loose end of the strap. Reposition and engage the backrests.

### Behind front seats

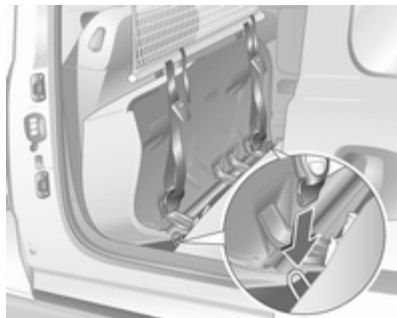

Pull up both rear seat cushions and fold down rear seat backrests. Open the cover of the installation opening in the roof frame above the front seats. Engage the net rod in one side, extend the rod and engage in the other side. Close the cover. Hook tensioning straps into brackets in floor and tighten by pulling on the loose end of the strap.

### ⚠ Warning

The brackets must not be used as lashing eyes to prevent objects that are being transported from sliding around.

### Removal

Swivel tensioning strap length adjusters upward and unhook straps. Open the cover. Unhook upper net rod and close cover. Roll the safety net.

### Load compartment grille



To enlarge the load compartment, the grille can be moved forwards on the front passenger's side.

Push the head restraint of the front passenger seat down as far as it will go ⇨ 33.

Tilt front passenger's seat backrest forward by raising release lever and push down to lock in position.

Engage lever on load compartment grille at top position, as shown in illustration.

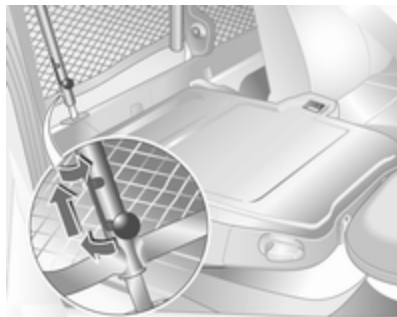

Engaging the lever prevents damage to the front passenger's seat.

Position load compartment grille above retainer in front passenger's seat backrest.



Lock load compartment grille in retainer. To do so, engage lever at bottom position.

### **⚠ Warning**

The load compartment grille must always be locked in one of the retainers when the vehicle is in use, and the lever must be engaged at its bottom position.

## Warning triangle

### Combo

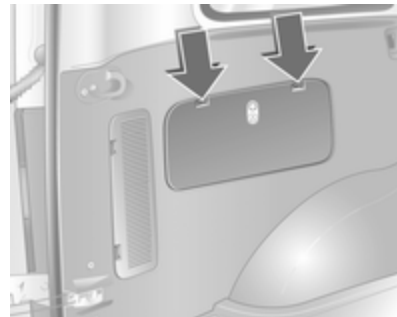

The warning triangle is stowed in a compartment in the side panel trim on the left-hand side.

Release flap by pressing retaining lugs.

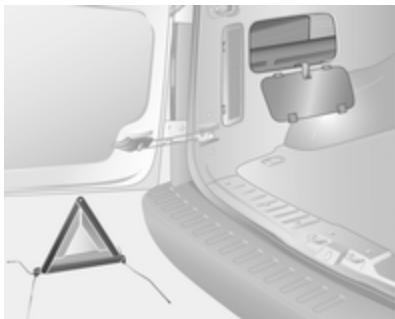

## Van

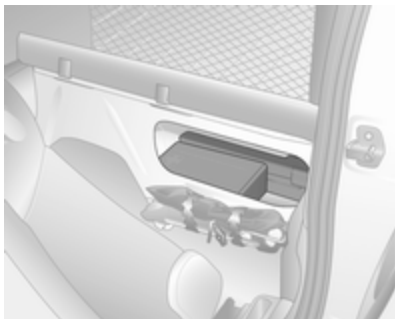

The warning triangle is kept in the compartment behind the driver's seat. When the vehicle is being loaded, please ensure that nothing protrudes over the bottom edge of the opening. Disengage flap by pressing retaining lug and remove.

## First aid kit

### Combo

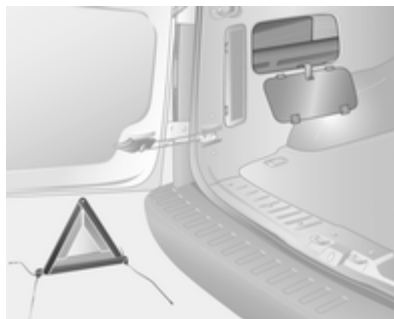

The first-aid kit (cushion) is stowed in a compartment in the side panel trim on the left-hand side.

Release flap by pressing retaining lugs.

## Van

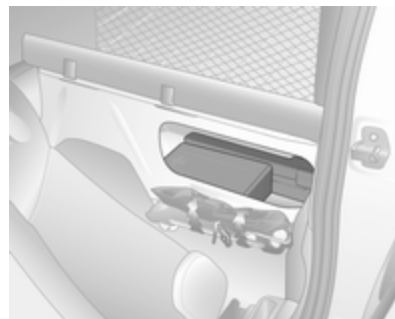

The first-aid kit (cushion) is kept in the compartment behind the driver's seat. When the vehicle is being loaded, please ensure that nothing protrudes over the bottom edge of the opening. Disengage flap by pressing retaining lug and remove.

## Roof rack system

### Roof rack

For safety reasons and to avoid damage to the roof, the vehicle approved roof rack system is recommended.

Follow the installation instructions and remove the roof rack when not in use.

## Loading information

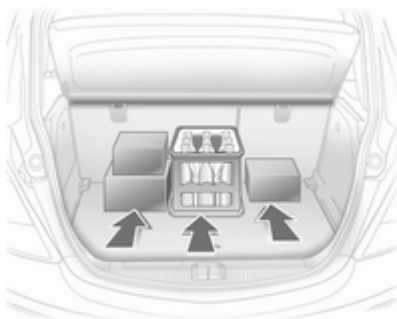

- Heavy objects in the load compartment should be placed against the seat backrests. Ensure the backrests are securely engaged. If objects can be stacked, the heavier objects should be placed at the bottom.
- Secure objects with lashing straps attached to lashing eyes.
- Secure loose objects in load compartment to prevent sliding.

- When transporting objects in the load compartment, the backrests of the rear seats must not be angled forward.
- Do not allow the load to protrude above the upper edge of the backrests.
- Do not place any objects on the load compartment cover or the instrument panel, and do not cover the sensor on top of the instrument panel.
- The load must not obstruct the operation of the pedals, parking brake and gear selector, or hinder the freedom of movement of the driver. Do not place any unsecured objects in the interior.
- Do not drive with an open load compartment.

**⚠ Warning**

Always make sure that the load in the vehicle is securely stowed. Otherwise objects can be thrown around inside the vehicle and cause personal injury or damage to the load or car.

- Do not cover the air outlets when stowing objects in the load compartment.

- The payload is the difference between the permitted gross vehicle weight (see identification plate ↻ 139) and the EC kerb weight.

To calculate the payload weight, enter the data for your vehicle in the Weights table at the front of this manual.

The EC kerb weight includes weights for the driver (68 kg), luggage (7 kg) and all fluids (tank 90 % full).

Optional equipment and accessories increase the kerb weight.

- Driving with a roof load increases the sensitivity of the vehicle to cross-winds and has a detrimental effect on vehicle handling due to the vehicle's higher centre of gravity. Distribute the load evenly and secure it properly with retaining straps. Adjust the tyre pressure and vehicle speed according to the load conditions.

Do not drive faster than 120 km/h. Check and retighten the straps frequently.

Do not drive faster than 75 mph. Check and retighten the straps frequently.

The permissible roof load is 100 kg. The roof load is the combined weight of the roof rack and the load.

- If objects are transported in the load compartment, the split load compartment grille must always be locked in one of the retainers and the lever must be engaged at its bottom position.

- When stowing objects in the stowage compartment above the front seats, secure against falling out.

## Instruments and controls

|   |    |
|---|----|
| Controls .....                              | 56 |
| Warning lights, gauges and indicators ..... | 61 |
| Information displays .....                  | 70 |
| Vehicle messages .....                      | 74 |

### Controls

#### Steering wheel adjustment

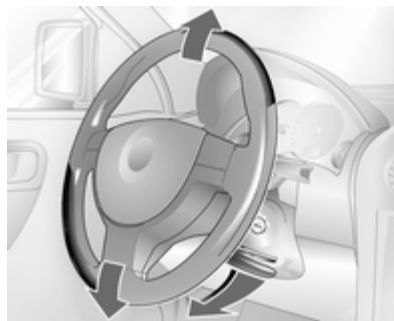

Unlock lever, adjust steering wheel, then engage lever and ensure it is fully locked.

Do not adjust steering wheel unless vehicle is stationary and steering wheel lock has been released.

### Steering wheel controls



The Infotainment system and the Info-Display can be operated via the controls on the steering wheel.

Further information is available in the Infotainment system manual.



## Horn

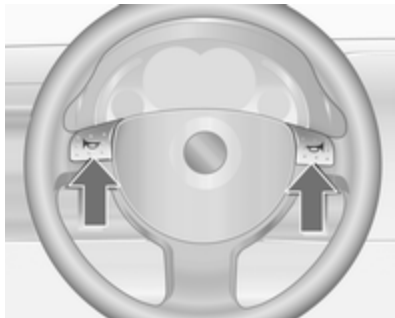





Press .

## Windscreen wiper/washer

### Windscreen wiper







Move lever upwards to switch on.

-  = fast
-  = slow
-  = interval wiping
-  = off

Do not use if the windscreen is frozen.

Switch off in car washes.

### Adjustable wiper interval

To set the wiper interval to a value between 2 and 15 seconds: Lever to interval operation , lever to , wait for required interval delay, lever to interval operation  again .

The selected interval will remain stored until the next time it is changed or until the ignition is switched off.

After turning on the ignition and setting the lever to , the interval is set to 7 seconds.

### Windscreen washer



Pull lever. Washer fluid is sprayed onto the windscreen and the wiper wipes a few times.

## Rear window wiper/washer



Push lever forwards. The rear window wiper wipes in interval mode. Switch off by pulling the lever.

If the lever is held forwards, washer fluid is sprayed onto the rear window.

Do not use if the rear window is frozen.

Switch off in car washes.

## Outside temperature

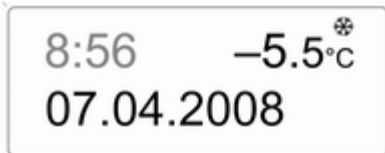

20001

A drop in temperature is indicated immediately and a rise in temperature after a time delay.

If outside temperatures drop to 3 °C, the symbol ❄ illuminates in the Triple-Info-Display or the Board-Info-Display as a warning for icy road conditions. ❄ remains illuminated until temperatures reach at least 5 °C.



20002

In vehicles with Graphic-Info-Display, a warning message appears in the display as a warning for icy road conditions. There is no message below -5 °C.

### ⚠ Warning

The road surface may already be icy even though the display indicates a few degrees above 0 °C.

## Clock

### Time display in odometer

To switch between trip odometer and time display give reset knob a short press.

### Setting the time

On the clock display, press the setting knob on the instrument for approx. 2 seconds. The flashing value is set by pressing briefly. Press for about 2 seconds again to switch to the next setting and at the end to exit setting mode.

## Power outlets



The power outlet is located in the centre console.

### Caution

Do not damage the outlet by using unsuitable plugs.

Connecting electrical accessories while the engine is off will discharge the battery. Do not exceed the maximum power consumption of 120 Watts. Do not connect any

current-delivering accessories, e.g. electrical charging devices or batteries.

Electrical accessories that are connected must comply with the electromagnetic compatibility requirements laid down in DIN VDE 40 839.

## Cigarette lighter



The cigarette lighter is located in the centre console.

With the ignition on, press in cigarette lighter. It switches off automatically once the element is glowing. Pull out lighter.

## Ashtrays

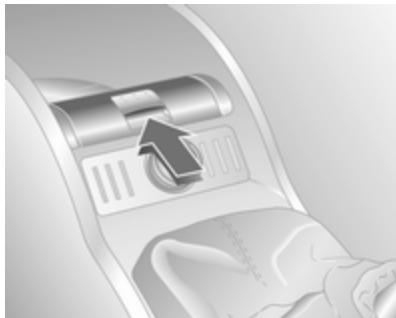

### Caution

To be used only for ash and not for combustible rubbish.

## Front ashtray



Open the ashtray cover to the resistance point.

To empty, open the ashtray cover fully beyond its resistance point, causing the insert to lift. Grip both sides of the ashtray insert and pull upwards.

To enlarge the storage compartment remove the ashtray completely.

## Rear ashtray

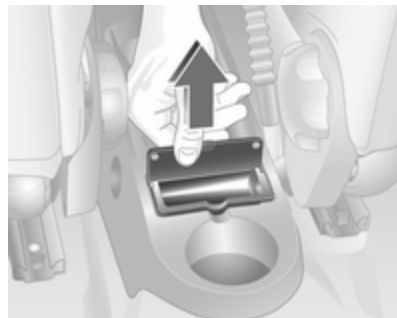

In the rear centre console.

To open, swivel the cover upwards.

To empty, lift the cover and pull the ashtray out upwards by its cover.

## Warning lights, gauges and indicators

### Speedometer



Indicates vehicle speed.

### Odometer



With the ignition switched off, briefly press the reset knob to display the number of kilometres driven for approx. 15 seconds.

The bottom line displays the recorded distance.

### Trip odometer

The top line displays the recorded distance since the last reset.

To reset, press button with ignition switched on and trip odometer activated and hold down for approximately one second.

### Vehicles with clock in odometer



To reset, press button with ignition switched on and trip odometer activated and hold down for approximately 2 seconds.

To switch between trip odometer and clock display give reset knob a brief press.

## Tachometer



Displays the engine speed.

Drive in a low engine speed range for each gear as much as possible.

### Caution

If the needle is in the red warning zone, the maximum permitted engine speed is exceeded. Engine at risk.

## Fuel gauge



Displays the fuel level in the tank.

If the fuel level is too low,  lights up. When the light flashes, refuel immediately.

Never run the tank dry.

On vehicles with auxiliary heating, regularly check the petrol level as it consumes petrol even during natural gas operation.

Because of the fuel remaining in the tank, the top-up quantity may be less than the specified tank capacity.

## Natural gas operation



The display indicates tank pressure or petrol level, depending on operating mode.

Pointer in left warning zone or  illuminated = Reserve level.

Pointer in left warning zone or  flashing = Lower reserve area; vehicle shifts automatically into petrol operation after a slight delay.

Display

- 1/1 - Tank pressure approx. 200 bar
- 3/4 - Tank pressure approx. 150 bar
- 1/2 - Tank pressure approx. 100 bar
- 1/4 - Tank pressure approx. 50 bar

In order to achieve the maximum range in natural gas operation, we recommend that you make use of the entire reserve area.

## Fuel selector



Pressing button  switches between petrol and natural gas operation. Switching is not possible at high loads

(e.g. strong acceleration, running at full throttle). The LED status shows the current operating mode.

Natural gas operation = LED off.

Petrol operation = LED illuminates.

As soon as the natural gas tanks are empty, petrol operation is automatically engaged until the ignition is switched off. This is indicated by prolonged flashing of the LED.

If the natural gas tanks are not refuelled, the system must be manually switched to petrol operation before the engine is started up again. This will prevent damage to the catalytic converter (overheating caused by irregular fuel supply).

If the selector switch is operated several times within a short time a switchover block is activated. The engine remains in the current operating mode. The block remains active until the ignition is switched off.

A slight loss of power and torque can be expected in petrol operation. You must therefore adapt your driving style (e.g. during overtaking manoeuvres) and vehicle loads (e.g. towing loads) accordingly.

Every six months run the petrol tank down until control indicator  illuminates and refuel. This is necessary to maintain fuel quality as well as system function necessary for petrol operation.

Fill the tank completely at regular intervals to prevent corrosion in the tank.

## Engine coolant temperature gauge



Displays the coolant temperature.

left area = engine operating temperature not yet reached

central area = normal operating temperature

right area = temperature too high

### Caution

If engine coolant temperature is too high, stop vehicle, switch off engine. Danger to engine. Check coolant level.

For physical reasons, the engine temperature gauge shows the coolant temperature only if the coolant level is adequate.

During operation the system is pressurised. The temperature may therefore rise briefly to over 100 °C.

## Service display



The message **InSP** appears when it is time for servicing. Further information ⇨ 135.



## Transmission display



The mode or selected gear is shown in the transmission display.

- R** = Reverse gear
- N** = Neutral position
- A** = Manual transmission  
automated: automatic mode
- 1 - 5** = Current gear, manual  
transmission automated,  
manual mode

## Control indicators

The control indicators described are not present in all vehicles. The description applies to all instrument

versions. When the ignition is switched on, most control indicators will illuminate briefly as a functionality test.

The control indicator colours mean:

- red = danger, important reminder
- yellow = warning, information, fault
- green = confirmation of activation
- blue = confirmation of activation

## Control indicators in the instrument

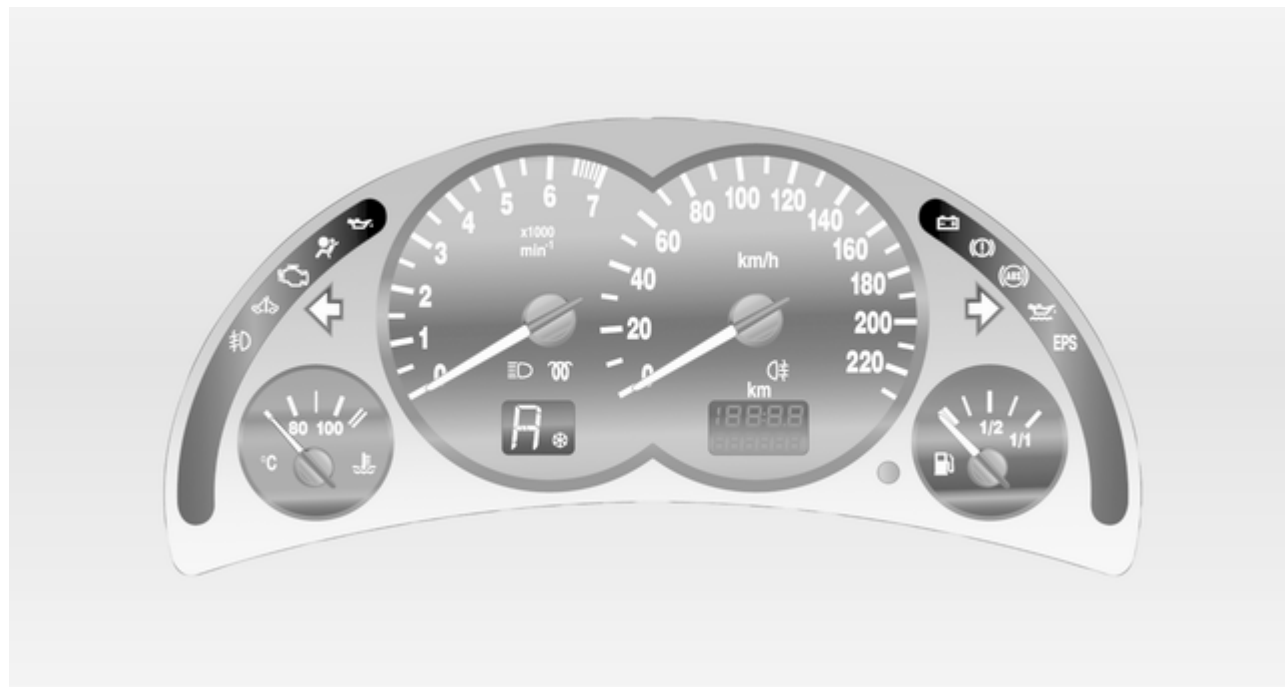

## Turn signal

↔ illuminates or flashes green.

### Flashes

The control indicator flashes if a turn signal is or the hazard warning flashers are activated.

Rapid flashing: failure of a turn signal light or associated fuse, failure of turn signal light on trailer.

Bulb replacement ↔ 105. Fuses  
↔ 113. Turn signals ↔ 77.

## Airbag and belt tensioners

☘ illuminates red.

Illuminates when the engine is running: Fault in the airbag or belt tensioner system.

### Warning

Have the cause of the fault remedied immediately by a workshop.

Airbag system, belt tensioners ↔ 39,  
↔ 37.

## Charging system

🔌 illuminates or flashes red.

Illuminates when the ignition is switched on and goes out shortly after the engine starts.

### Illuminates when the engine is running

Stop, switch off engine. Battery is not charging. Engine cooling may be interrupted. In diesel engines, power to the brake servo unit may be cut. Seek the assistance of a workshop.

## Malfunction indicator light

🚗 illuminates or flashes yellow.

Illuminates when the ignition is switched on and goes out shortly after the engine starts.

### Illuminates when the engine is running

Fault in the emission control system. The permitted emission limits may be exceeded. Immediately seek the assistance of a workshop.

## Flashes when the engine is running

Fault that could lead to catalytic converter damage. Ease up on the accelerator until the flashing stops. Seek the assistance of a workshop immediately.

## Service vehicle soon

🚗 illuminates or flashes yellow.

### Illuminates when the engine is running

Fault in engine or transmission electronics. The electronics switch to an emergency running programme. Fuel consumption may be increased and the vehicle handling may be impaired.

If the fault persists after restarting the vehicle, consult a workshop.

In vehicles with diesel engines, it may be necessary to drain the diesel fuel filter ↔ 86.

### Flashes with switched on ignition

Fault in the immobiliser system. The engine cannot be started ⇨ 28.

### Brake and clutch system

Ⓢ illuminates or flashes red.

### Illuminates

Illuminates when the parking brake is released if the brake and clutch fluid level is too low ⇨ 103.

#### Warning

Stop. Do not continue your journey. Consult a workshop.

Illuminates after the ignition is switched on if the parking brake is applied ⇨ 93.

### Flashes

On vehicle with automated manual transmission, Ⓢ flashes for a few seconds when the ignition is switched off if the parking brake is not applied.

### Antilock brake system (ABS)

Ⓢ illuminates red.

If the control indicator illuminates while driving, there is a fault in the ABS.

Anti-lock Braking System ⇨ 92.

### Winter mode

Symbol is lit in the transmission display if the Winter programme is activated ⇨ 90.

### Power steering

EPS illuminates yellow.

Fault in power steering system. The power steering may have failed. The vehicle can be steered but considerably more force is required. Contact a workshop.

### Preheating and diesel particle filter

Ⓢ illuminates or flashes yellow.

### Illuminates

Preheating activated. Only activates when outside temperature is low.

### Flashes

(in vehicles fitted with a diesel particle filter).

Control indicator Ⓢ flashes if the filter requires cleaning and previous driving conditions did not permit automatic cleaning. Continue driving and if possible do not allow engine speed to drop below 2000 rpm.

The control indicator Ⓢ goes off as soon as the self-cleaning operation is complete.

Diesel particle filter ⇨ 86.

### Engine oil pressure

Ⓢ illuminates red.

Illuminates for a few seconds after the ignition is switched on.

## Illuminates when the engine is running

### Caution

Engine lubrication may be interrupted. This may result in damage to the engine and/or locking of the drive wheels.

1. Depress clutch.
2. Select neutral gear, set selector lever to **N**.
3. Move out of the flow of traffic as quickly as possible without impeding other vehicles.
4. Switch off ignition.

### Warning

When the engine is off, considerably more force is needed to brake and steer.

Do not remove key until vehicle is stationary, otherwise the steering wheel lock could engage unexpectedly.

Check oil level before seeking the assistance of a workshop ⇨ 101.

## Low engine oil level

 illuminates yellow.

Engine oil level is checked automatically.

## Illuminates when the engine is running

Low engine oil level. Check engine oil level and top up as necessary ⇨ 101.

## Low fuel

 illuminates or flashes yellow.

## Illuminates

Level in fuel tank too low.

## Flashes

Fuel used up. Refuel immediately. Never run the tank dry.

Erratic fuel supply can cause catalytic converter to overheat ⇨ 87.

Bleeding the diesel fuel system ⇨ 104.

## High beam

 illuminates blue.

Illuminated when high beam is on and during headlight flash ⇨ 75.

## Fog light

 illuminates green.

Illuminated when the front fog lights are on ⇨ 77.

## Rear fog light

 illuminates yellow.

Illuminated when the rear fog light is on ⇨ 77.

## Information displays

### Triple-Info-Display

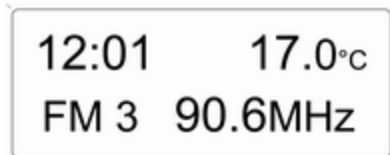

20004

Displays time, outside temperature and date or Infotainment system (when it is on).

When the ignition is off, the time, date and outside temperature can be displayed by briefly pressing one of the two buttons below the display.

### Graphic-Info-Display, Colour-Info-Display

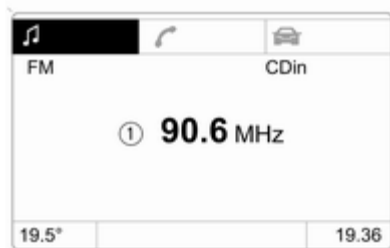

Displays time, outside temperature, date or Infotainment system (when it is on).

The type of information and how it is displayed depend on the equipment of the vehicle and the settings made.

### Selecting functions

The graphical information display depicts functions and their menus.

Functions are selected and executed in the menu on the display using the four-way button, the multifunction button on the infotainment system or the buttons on the steering wheel.

### Selecting with the four-way button

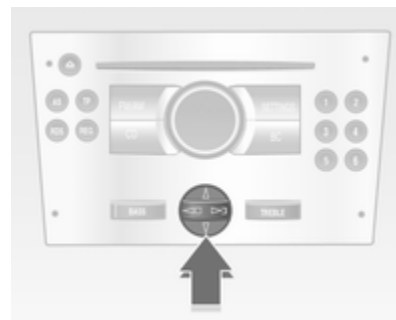

Select menu items via menus and with the buttons/four-way button of the infotainment system.

### Selecting with the multifunction control



Turn the multifunction control to highlight menu items or commands and to select function areas.

Press the multifunction control to select the highlighted item or confirm a command.

To exit a menu, turn the multifunction control until **Return** or **Main** appear and select.

### Selecting with the steering wheel buttons



Select menu options via the menus using the buttons.

### Function areas



For each function area there is a main page (Main), which is selected at the top edge of the display (not with Infotainment system CD 30 or the Mobile Phone Portal):

- Audio
- Navigation
- Telephone

## System settings



20013

Press the **Main** button of the Infotainment system.

Press the **Settings** button on the Infotainment system. For Infotainment system CD 30, no menu may be selected.

## Setting date and time



20014

Select menu item **Time, Date** from the **Settings** menu.

Select the required menu items and make settings.

### Automatic time synchronisation

The RDS signal of most VHF transmitters automatically sets the time.

Some transmitters do not send a correct time signal. In such cases, we recommend to switch off automatic time synchronisation.

On Infotainment systems with navigation, time and date are also harmonised upon receipt of a GPS satellite signal.

The function is activated by ticking the field in front of **Synchron. clock automatical**. in the **Time, Date** menu.

## Language selection

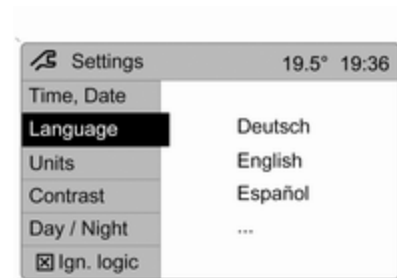

20015

The display language for some functions can be selected.

Select menu item **Language** from the **Settings** menu.

Select the desired language.





20016

Selection is indicated by a ▶ in front of the menu item.

In systems with voice output, when the language setting of the display is changed the system will ask whether the announcement language should also be changed - see Infotainment system manual.

### Setting units of measure



20017

Select menu item **Units** from the **Settings** menu.

Select the desired unit.

Selections are indicated by a ● in front of the menu item.

### Adjusting contrast (Graphic-Info-Display)

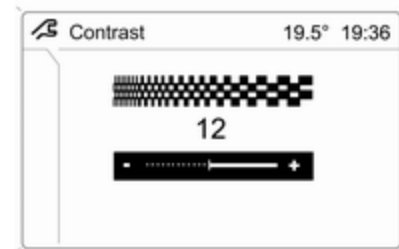

20018

Select menu item **Contrast** from the **Settings** menu.

Confirm the required setting.

### Setting display mode

Display brightness is dependent of vehicle lighting. Additional settings can be made as follows:

Select menu item **Day/Night** from the **Settings** menu.

**Automatic:** adapted based on exterior lighting.

**Always day design:** black text on light background.

**Always night design:** white text on dark background.

Selection is indicated by a ● in front of the menu item.

### **Ignition logic**

See Infotainment system manual.

## **Vehicle messages**

### **Warning chimes**

#### **When starting the engine or whilst driving**

- If seat belt is not fastened.
- If the speed programmed at the factory is exceeded.
- If the vehicle has automated manual transmission and the driver's door is opened when the engine is running, a gear is engaged and the foot brake is not depressed.

#### **When the vehicle is parked and the driver's door is opened**

- When the key is in the ignition switch.
- With exterior lights on.
- If the turn signal lever is engaged.

## Lighting

|                         |    |
|-------------------------|----|
| Exterior lighting ..... | 75 |
| Interior lighting ..... | 78 |
| Lighting features ..... | 79 |

## Exterior lighting

### Light switch



Turn light switch:

**0** = OFF

 = Sidelights

 = Headlights

Control indicator   69.

### Daytime running light

If the light switch is set to **0**, dipped beam is activated without instrument illumination when the ignition is switched on.

## Tail lights

Tail lights are illuminated together with headlights and sidelights.

## High beam

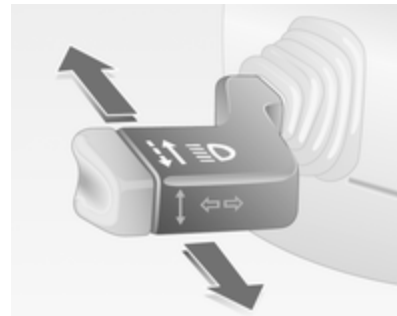

To switch from low to high beam, push lever.

To switch to low beam, push lever again or pull.

## Headlight flash

To activate the headlight flash, pull lever.

## Headlight range adjustment

### Manual headlight range adjustment



Rotate the adjuster wheel to the required position to adjust the dipped beam range to vehicle loading and prevent dazzling.

#### Combo

- 0 = Front seats occupied
- 1 = All seats occupied

- 2 = All seats occupied and load compartment laden
- 3 = Driver's seat occupied and load compartment laden

#### Combo van

- 0 = Seats occupied
- 1 = Seats occupied and half load in load compartment
- 2 = Seats occupied and full load in load compartment
- 3 = Driver's seat occupied and full load in load compartment

## Headlights when driving abroad

The asymmetrical headlight beam extends visibility at the edge of the road at the passenger side.

However, when driving in countries where traffic drives on the opposite side of the road, adjust the headlights to prevent dazzling of oncoming traffic.

Have the headlights adjusted by a workshop.

## Hazard warning flashers

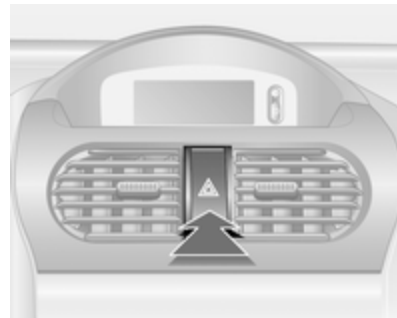

Operated with the  button.

## Turn and lane-change signals

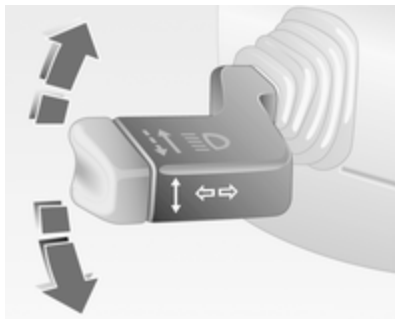

Lever up = right turn signal  
Lever down = left turn signal

If the lever is moved past the resistance point, the turn signal is switched on constantly. When the steering wheel moves back, the turn signal is automatically deactivated.

Move the lever to the resistance point and hold for longer indication. Press the lever until resistance is felt: The turn signal light remain on until the lever is released.

Switch the turn signal off manually by moving the lever slightly.

## Front fog lights



The front fog lights can only be switched on when both the ignition and headlights or sidelights are on. Operated with the  $\text{D}$  button.

## Rear fog lights

Operated with the  $\text{D}$  button.

The rear fog light can only be switched on when both the ignition and headlights or sidelights are on.

The vehicle rear fog light is deactivated when towing.

## Misted light covers

The inside of the light covers may mist up briefly in poor, wet and cold weather conditions, in heavy rain or after washing. The mist disappears quickly by itself; to help, switch on the headlights.

## Interior lighting

### Instrument panel illumination control



Brightness of the following lights can be adjusted when the exterior lights are on:

- Instrument panel illumination
- Info-Display
- Illuminated switches and operation elements

Turn thumb wheel  until the required brightness is obtained.

## Interior lights

During entry and exit of the vehicle, the front and centre courtesy lights automatically come on and then switch off after a delay.

### Front courtesy light



To operate manually when the doors are closed:

On = Press light switch .

Off = Press light switch  again.

## Load compartment lighting

The lighting switches on when opened.

### Reading lights

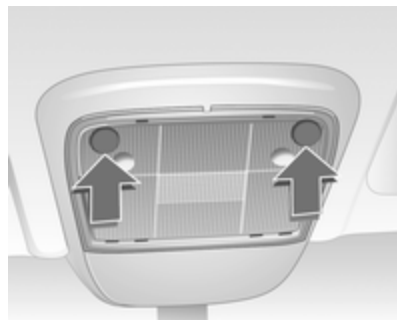

Operated with the button with ignition on.

---

## Lighting features

### Centre console lighting

Spotlight in interior mirror housing.  
Daylight-dependent, automatically regulated centre console lighting.

### Battery discharge protection

Some consumers such as the interior lighting switch themselves off after approx. 30 minutes if the ignition is off in order to protect the battery charge.

## Climate control

|                               |    |
|-------------------------------|----|
| Climate control systems ..... | 80 |
| Air vents .....               | 82 |
| Maintenance .....             | 82 |

## Climate control systems

### Heating and ventilation system



Controls for:

- Temperature
- Fan speed
- Air distribution

Heated rear window  → 32.

### Temperature





red = warm  
blue = cold

Heating will not be fully effective until engine has reached normal operating temperature.

### Fan speed



Adjust the air flow by switching the fan to the desired speed.

### Air distribution

-  = to head area
-  = to head area and foot well
-  = to foot well
-  = to windscreen, front door windows and foot well
-  = to windscreen and front door windows

Intermediate settings are possible.

### Demisting and defrosting the windows

- Set temperature control to warmest level.
- Set fan speed to highest level.
- Set air distribution control to .
- Switch on heated rear window .



- Open side air vents as required and direct them towards door windows.
- For simultaneous warming of the foot well, set air distribution control to .

## Air conditioning system



In addition to the heating and ventilation system, the air conditioning system has:

-  = cooling
-  = air recirculation

Heated seats   36.

### Cooling

Operated with the  button and is functional only when the engine and fan are running.

The air conditioning system cools and dehumidifies (dries) as soon as the outside temperature is slightly above the freezing point. Therefore condensation may form and drip from under the vehicle.

If no cooling or drying is required, switch the cooling system off to save fuel.

### Air recirculation system

The air recirculation mode is operated with the  button.



#### Warning

The exchange of fresh air is reduced in air recirculation mode. In operation without cooling the air humidity increases, so the windows may mist up. The quality of the passenger compartment air deteriorates, which may cause the vehicle occupants to feel drowsy.



Air distribution to : Air recirculation is deactivated.

### Maximum cooling

Briefly open the windows so that hot air can disperse quickly.

- Cooling  on.
- Air circulation system  on.
- Set temperature control to coldest level.
- Set fan speed to highest level.
- Set air distribution control to .
- Open all vents.

### Demisting and defrosting the windows

- Cooling  on.
- Set temperature control to warmest level.
- Set fan speed to highest level.
- Set air distribution control to .
- Switch on heated rear window .
- Open side air vents as required and direct them towards the door windows.

## Air vents

### Adjustable air vents

At least one air vent must be open while cooling is on in order to prevent the evaporator from icing up due to lack of air movement.

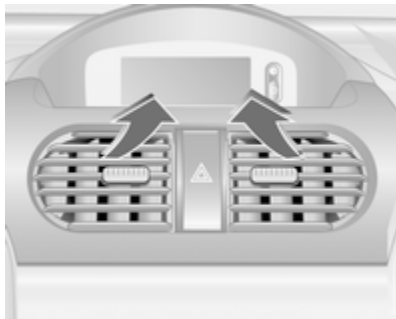

Set the direction of the air flow by turning the adjuster wheel from right to left and raise or lower the horizontal slats.

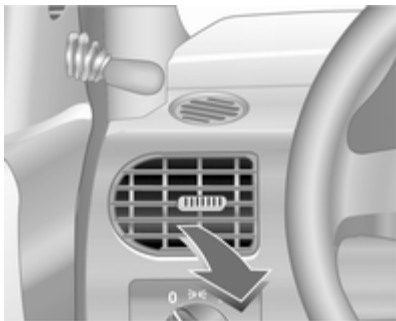

To close the vent, turn the adjuster wheel to left or right to its stop.

### **⚠ Warning**

Do not attach any objects to the slats of the air vents. Risk of damage and injury in case of an accident.

### Fixed air vents

Additional air vents are located beneath the windscreen and door windows and in the foot wells.

## Maintenance

### Air intake

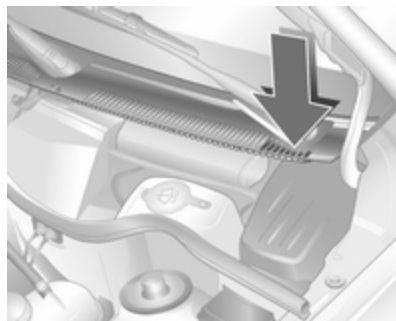

The air intake in front of the windscreen in the engine compartment must be kept clear to allow air intake. Remove any leaves, dirt or snow.

### Pollen filter

The pollen filter cleans dust, soot, pollen and spores from the air entering the vehicle through the air intake.

## Air conditioning regular operation

In order to ensure continuously efficient performance, cooling must be operated for a few minutes once a month, irrespective of the weather and time of year. Operation with cooling is not possible when outside temperature is too low.

## Service

For optimal cooling performance, it is recommended to annually check the climate control system, starting three years after initial vehicle registration, including:

- Functionality and pressure test
- Heating functionality
- Leakage check
- Check of drive belts
- Cleaning of condenser and evaporator drainage
- Performance check

## Driving and operating

|  |    |
|--|----|
| Driving hints .....                    | 84 |
| Starting and operating .....           | 84 |
| Engine exhaust .....                   | 86 |
| Manual transmission .....              | 88 |
| Manual transmission<br>automated ..... | 89 |
| Brakes .....                           | 92 |
| Fuel .....                             | 94 |
| Towing .....                           | 97 |

## Driving hints

### Control of the vehicle

#### **Never coast with engine not running**

Many systems will not function in this situation (e.g. brake servo unit, power steering). Driving in this manner is a danger to yourself and others.

#### **Pedals**

To ensure the pedal travel is uninhibited, there must be no mats in the area of the pedals.

## Starting and operating

### New vehicle running-in

Do not brake unnecessarily hard for the first few journeys.

During the first drive, smoke may occur because of wax and oil evaporating off the exhaust system. Park the vehicle in the open for a while after the first drive and avoid inhaling the fumes.

During the running-in period fuel and engine oil consumption may be higher and the cleaning process of the diesel particle filter may take place more often. Diesel particle filter  
⇨ 86.

## Ignition switch positions

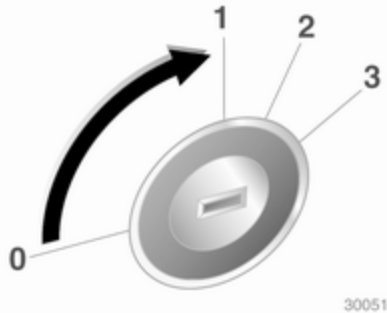

- 0 = Ignition off
- 1 = Steering wheel lock released, ignition off
- 2 = Ignition on, for diesel engine: preheating
- 3 = Starting

## Starting the engine

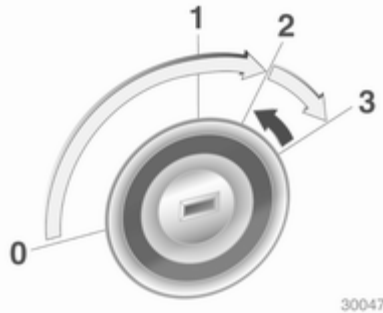

Operate clutch and brake, automatic transmission in **P** or **N**.

Do not operate accelerator pedal.

Diesel engine: turn the key to position **2** for preheating and wait until control indicator  goes out.

Turn key briefly to position **3** and release.

Before restarting or to switch off the engine, turn key back to **0**.

## Starting the vehicle at low temperatures

The start of the engine without additional heaters is possible down to  $-25\text{ }^{\circ}\text{C}$  for diesel engines and  $-30\text{ }^{\circ}\text{C}$  for petrol engines. Required is an engine oil with the correct viscosity, the correct fuel, performed services and a sufficiently charged battery. With temperatures below  $-30\text{ }^{\circ}\text{C}$  the manual transmission automated need a warming phase of approx. 5 minutes. The selector lever must be in position **N**.

## Overrun cut-off

The fuel supply is automatically cut off during overrun, i.e. when the vehicle is driven with a gear engaged but accelerator is released. Overrun cut-off is deactivated if catalytic converter temperature is high.

## Parking

- Do not park the vehicle on an easily ignitable surface. The high temperature of the exhaust system could ignite the surface.
- Always apply parking brake without pressing release button. Apply as firmly as possible on downhill or uphill slopes. Depress the foot brake at the same time to reduce operating force.
- Switch off the engine and ignition. Turn the steering wheel until the steering wheel lock engages.
- If the vehicle is on a level surface or uphill slope, engage first gear or set the selector lever to **P** before switching off the ignition. On an uphill slope, turn the front wheels away from the kerb.

If the vehicle is on a downhill slope, engage reverse gear or set the selector lever to **P** before switching off the ignition. Turn the front wheels towards the kerb.

- Lock the vehicle and activate the anti-theft locking system and the anti-theft alarm system.

## Engine exhaust

### Danger

Engine exhaust gases contain poisonous carbon monoxide, which is colourless and odourless and could be fatal if inhaled.

If exhaust gases enter the interior of the vehicle, open the windows. Have the cause of the fault rectified by a workshop.

Avoid driving with an open load compartment, otherwise exhaust gases could enter the vehicle.

## Diesel particle filter

The diesel particle filter system filters harmful soot particles out of the exhaust gases. The system includes a self-cleaning function that runs automatically during driving. The filter is cleaned by burning off the soot particles at high temperature. This process takes place automatically under set driving conditions and may take up to 25 minutes. Fuel

consumption may be higher during this period. The emission of smells and smoke during this process is normal.



Under certain driving conditions, e.g. short distances, the system cannot clean itself automatically.

If the filter requires cleaning and previous driving conditions did not enable automatic cleaning, control indicator  flashes. Continue driving, keeping engine speed above 2000 revolutions per minute. Shift down if necessary. Diesel particle filter cleaning is then started.

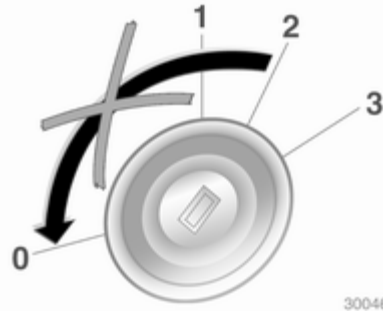

Stopping the journey or switching off the engine during cleaning is not recommended.

### Caution

If the cleaning process is interrupted more than once, there is a great risk of provoking severe engine damage.

Cleaning takes place quickest at high engine speeds and loads.



The control indicator  extinguishes as soon as the self-cleaning operation is complete.

If  illuminates additionally, cleaning is not possible, seek the assistance of a workshop.

## Catalytic converter

The catalytic converter reduces the amount of harmful substances in the exhaust gases.

**Caution**

Fuel grades other than those listed on pages ⇨ 94, ⇨ 141 could damage the catalytic converter or electronic components.

Unburnt petrol will overheat and damage the catalytic converter. Therefore avoid excessive use of the starter, running the fuel tank dry and starting the engine by pushing or towing.

In the event of misfiring, uneven engine running, a reduction in engine performance or other unusual problems, have the cause of the fault rectified by a workshop as soon as possible. In an emergency, driving can be continued for a short period, keeping vehicle speed and engine speed low.

**Manual transmission**

To engage reverse, with the vehicle stationary wait 3 seconds after depressing the clutch pedal and then pull up the button on the selector lever and engage the gear.

If the gear does not engage, set the lever to neutral, release the clutch pedal and depress again; then repeat gear selection.

Do not grind the clutch unnecessarily.

When operating, depress the clutch pedal completely. Do not use the pedal as a foot rest.

**Caution**

It is not advisable to drive with the hand resting on the selector lever.



## Manual transmission automated

The Easytronic transmission permits manual (manual mode) or automatic gear shifting (automatic mode), both with automatic clutch control.

### Transmission display



Shows the mode and current gear.

If the Winter programme is activated,  is illuminated.

## Starting the engine

Depress the foot brake when starting the engine. If the foot brake is not depressed, "N" flashes in the transmission display and the engine cannot be started.

Starting is not possible if all brake lights fail.

### Selector lever



Always move the selector lever in the appropriate direction as far as it will go.

**N** = Neutral position.

**A/M** = Switch between automatic and manual mode. The transmission display shows **A** or **M**.

**R** = Reverse gear. Press knob on selector lever, select **R**. Engage only when vehicle is stationary.

**+** = Shift to a higher gear.

**-** = Shift to a lower gear.

### Selector lever in ● (centre position)

Moving the selector lever from **N** to ● (centre position) while depressing the foot brake time switches to automatic mode and engages first gear (second gear if winter programme is enabled).

The vehicle starts to move when the brake is released. If the foot brake is not operated, **A** starts to flash. Start off by immediately pressing the accelerator pedal or move selector lever back to **N** and repeat procedure with foot brake operated.

## Manual mode

In manual mode, a gear can be selected manually by tapping the selector lever to the **+** or **-** position. The transmission display indicates the current gear.

If the engine speed is too low the manual transmission automated will automatically shift to a lower gear even in Manual mode.

If a higher gear is selected when the running speed is too low, or a lower gear when the speed is too high, no shift is carried out. This prevents the engine from running at too low or too high an engine speed.

Gears can be skipped by jogging the selector lever repeatedly at short intervals.

When the vehicle is in automatic mode, manual transmission automated switches to manual mode when the selector lever is tapped to position **+** or **-**.

## Stopping the vehicle

In **A**, first gear is engaged (second gear if the Winter programme is engaged) and the clutch is released when the vehicle is stopped. In **R**, reverse gear remains engaged.

## Engine braking

### Automatic mode

When driving downhill, the manual transmission automated does not shift into higher gears until a fairly high engine speed has been reached. It shifts down in good time when braking.

### Manual mode

To utilise the engine braking effect, select a lower gear in good time when driving downhill.

## Rocking the vehicle

Rocking the vehicle is only permissible if the vehicle is stuck in sand, mud or snow. Move the selector lever between **R** and **●** in a repeat pattern. Do not race the engine and avoid sudden acceleration.

## Parking

Apply the parking brake. The most recently engaged gear (see transmission display) remains engaged. With **N**, no gear is engaged. When the ignition is switched off the transmission no longer responds to movement of the selector lever.

## Electronic driving programmes

- Following a cold start, the operating temperature programme increases engine speed to quickly bring the catalytic converter to the required temperature.
- The adaptive programme tailors gearshifting to the driving conditions, e.g. greater load or gradients.

## Winter mode ❄️



Activate the Winter mode if you have problems starting off on a slippery road surface.

### Activation

Press the ❄️ button. The transmission switches to automatic mode. The vehicle starts off in 2nd gear.

### Deactivation

The Winter mode is switched off by:

- pressing the ❄️ button again
- turning off the ignition

- switching to manual mode
- when clutch temperature is too high

## Kickdown

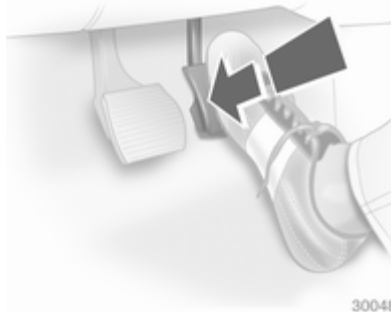

30048

If the accelerator pedal is pressed past the pressure point, the transmission shifts to a lower gear depending on engine speed.

During kickdown no manual gear shifting is possible.

When the engine speed approaches its upper limit, the transmission shifts to a higher gear during kickdown even in manual mode.

Without kickdown this automatic shift is not effected in manual mode.

## Fault

To prevent damage to the manual transmission automated, the clutch is engaged automatically at high clutch temperatures.

⚠️ illuminates in the event of a fault. Continued driving is possible. Manual mode cannot be used for shifting.

If **F** appears in the transmission display, continued driving is not possible.

Have the cause of the fault remedied by a workshop.

## Interruption of power supply

The clutch is not disengaged if there is an interruption of the power supply when a gear is engaged. The vehicle cannot move.

If the battery is discharged, start the vehicle using jump leads ⇨ 129.

If the cause of the fault is not a discharged battery, seek the assistance of a workshop.

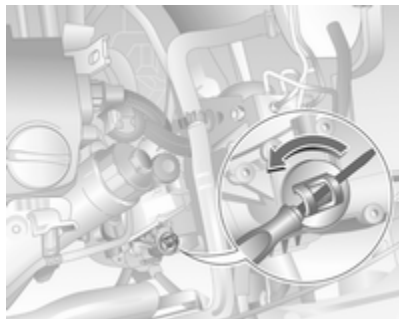

If the vehicle must be moved out of the flow of traffic, disengage the clutch as follows:

1. Apply parking brake and switch off ignition.
2. Open the bonnet ⇨ 100.
3. Clean the transmission around the cap so that no dirt can get into the opening when the cap is removed.
4. Rotate cap to slacken and remove by lifting upwards.

5. Using a flat-head screwdriver, turn the adjusting screw under the cap clockwise until clear resistance can be felt. The clutch has now been disengaged.

#### **Caution**

Do not turn beyond the resistance since this could damage the transmission.

6. Refit cleaned cap. The cap must be in full contact with the housing.

#### **Caution**

Towing the vehicle and starting the engine is not permitted when the clutch has been disengaged in this way, although the vehicle can be moved a short distance.

Seek the immediate assistance of a workshop.

## **Brakes**

The brake system comprises two independent brake circuits.

If a brake circuit fails, the vehicle can still be braked using the other brake circuit. However, braking effect is achieved only when the brake pedal is depressed firmly. Considerably more force is needed for this. The braking distance is extended. Seek the assistance of a workshop before continuing your journey.

When the engine is not running, the support of the brake servo unit disappears once the brake pedal has been depressed once or twice. Braking effect is not reduced, but braking requires significantly greater force. It is especially important to bear this in mind when being towed.

Control indicator (I) ⇨ 68.

## **Antilock brake system**

Antilock brake system (ABS) prevents the wheels from locking.

ABS starts to regulate brake pressure as soon as a wheel shows a tendency to lock. The vehicle remains steerable, even during hard braking.

ABS control is made apparent through a pulse in the brake pedal and the noise of the regulation process.

For optimum braking, keep the brake pedal fully depressed throughout the braking process, despite the fact that the pedal is pulsating. Do not reduce the pressure on the pedal.

After starting off the system performs a self test which may be audible.

Control indicator  ↪ 68.

### Adaptive brake light

During full braking, all three brake lights flash for the duration of ABS control.

## Fault

### Warning

If there is a fault in the ABS, the wheels may be liable to lock due to braking that is heavier than normal. The advantages of ABS are no longer available. During hard braking, the vehicle can no longer be steered and may swerve.

Have the cause of the fault remedied by a workshop.

## Parking brake

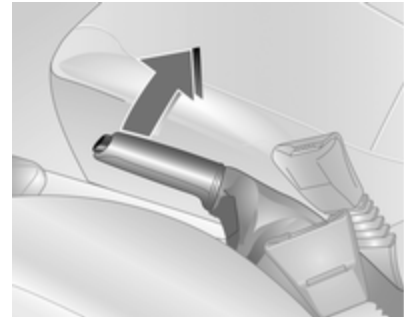

Always apply parking brake firmly without operating the release button, and apply as firmly as possible on a downhill or uphill slope.

To release the parking brake, pull the lever up slightly, press the release button and fully lower the lever.

To reduce the operating forces of the parking brake, depress the foot brake at the same time.

Control indicator  ↪ 68.

## Brake assist

If the brake pedal is depressed quickly and forcefully, maximum brake force is automatically applied (full braking).

Maintain steady pressure on the brake pedal for as long as full braking is required. Maximum brake force is automatically reduced when the brake pedal is released.

## Fuel

### Fuel for petrol engines

Only use unleaded fuel that complies with DIN EN 228.

Equivalent standardised fuels with an ethanol content of max. 10 % by volume may be used. In this case only use fuel that complies with DIN 51625.

Use fuel with the recommended octane rating ⇨ 141. Use of fuel with too low an octane rating can reduce engine power and torque and slightly increases fuel consumption.

| Caution  |
|--|
| Use of fuel with too low an octane rating could lead to uncontrolled combustion and engine damage. |

### Fuel for diesel engines

Only use diesel fuel that complies with DIN EN 590. The fuel must have low sulphur content (max. 50 ppm). Equivalent standardised fuels with

a biodiesel (= FAME according to EN14214) content of max. 7 % by volume (like DIN 51628 or equivalent standards) may be used.

Do not use marine diesel oils, heating oils or entirely or partially plant-based diesel fuels, such as rape seed oil or biodiesel, Aquazole and similar diesel-water emulsions. Diesel fuels must not be diluted with fuels for petrol engines.

The flow and filterability of diesel fuel are temperature-dependent. When temperatures are low, refuel with diesel fuel with guaranteed winter properties.

### Fuel for natural gas operation

Use natural gas with a methane content of approx. 78 - 99 %. L-gas (low) has approx. 78 - 87 % and H-gas (high) has approx. 87 - 99 %. Biogas with the same methane content can also be used if it has been chemically prepared and desulphurised.

Only use natural gas or biogas that complies with DIN 51624.

Liquid gas or LPG must not be used.

## Refuelling

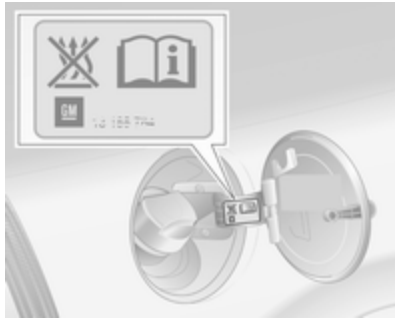

### **⚠ Danger**

Before refuelling, switch off engine and any external heaters with combustion chambers (identified by sticker on fuel filler flap). Switch off any mobile phones.

Follow the operating and safety instructions of the filling station when refuelling.

### **⚠ Danger**

Fuel is flammable and explosive. No smoking. No naked flames or sparks.

If you can smell fuel in your vehicle, have the cause of this remedied immediately by a workshop.

### **Caution**

In case of misfuelling, do not switch on ignition.

Fuel filler flap is located at right rear side of vehicle.

With a central locking system with remote control, the tank flap is unlocked at the same time as the doors.

Open tank flap.

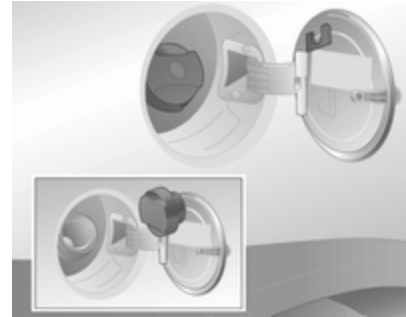

Unlock the fuel filler cap with the ignition key, unscrew and remove. The fuel filler cap can be retained in the bracket on the fuel filler flap.

**Caution**

Wipe off any overflowing fuel immediately.

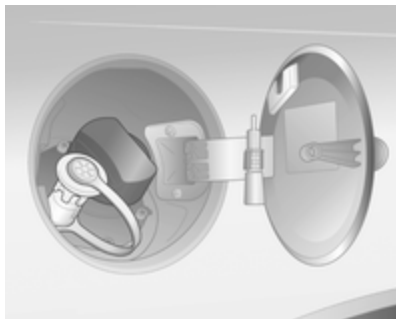
**Natural gas refuelling**

When filling with natural gas, remove the protective cap from the filler neck.

**⚠ Warning**

Refuel only with a maximum output pressure of 250 bar. Use only temperature compensated filling stations.

The refuelling procedure must be completed, i.e. the filler neck must be vented. Refit the protective cap.

The capacity of the natural gas tank depends on outside temperature, filling pressure and type of refuelling system.

Terms for "natural gas vehicles" abroad:

German Erdgasfahrzeuge

English NGVs = Natural Gas Vehicles

French Véhicules au gaz naturel – or – Véhicules GNV

Italian Metano auto

Terms for "natural gas" abroad:

German Erdgas

English CNG = Compressed Natural Gas

French GNV = Gaz Naturel (pour)  
Véhicules - or -  
CGN = carburantgaz naturel

Italian Metano (per auto)

**Fuel filler cap**

Only use genuine fuel filler caps. Diesel-engined vehicles have special fuel filler caps.

**Fuel consumption - CO<sub>2</sub>-Emissions**

The determination of fuel consumption is regulated by European directive 80/1268/EEC (latest edition 2004/3/EC).

The directive is oriented to actual driving practices: Urban driving is rated at approx.  $\frac{1}{3}$  and extra urban



driving with approx.  $\frac{2}{3}$ . Cold starts and acceleration phases are also taken into consideration.

The specification of CO<sub>2</sub> emission is also a constituent of the directive.

The figures given must not be taken as a guarantee for the actual fuel consumption of a particular vehicle. Furthermore, fuel consumption is dependent on personal driving style as well as road and traffic conditions.

All values are based on the EU base model with standard equipment.

The calculation of fuel consumption takes into account the vehicle's kerb weight, ascertained in accordance with the regulations. Optional equipment may result in slightly higher fuel consumption and CO<sub>2</sub> emission levels and a lower maximum speed.

Fuel consumption, CO<sub>2</sub> emissions  
↔ 142.

## Towing

### General information

Only use towing equipment that has been approved for your vehicle. Entrust retrofitting of towing equipment to a workshop. It may be necessary to make changes that affect the cooling system, heat shields or other equipment.

Fitting of towing equipment could cover the opening of the towing eye. If this is the case use the coupling ball bar for towing. Always keep the coupling ball bar in the vehicle.

Installation dimensions of factory-fitted towing equipment ↔ 154.

### Driving characteristics and towing tips

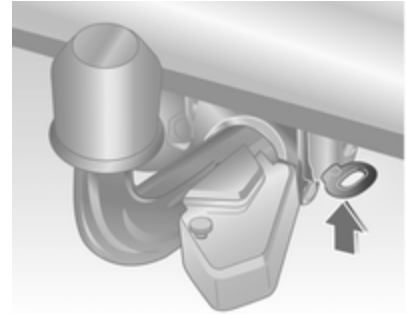

Before attaching a trailer, lubricate the coupling ball. However, do not do so if a stabiliser, which acts on the coupling ball, is being used to reduce snaking movements.

For trailers with low driving stability and caravan trailers with a permitted gross vehicle weight of more than 1000 kg a speed of 50 mph must not be exceeded; the use of a stabiliser is recommended.

For trailers with low driving stability and caravan trailers with a permitted gross vehicle weight of more than 1000 kg a speed of 80 km/h must not be exceeded; the use of a stabiliser is recommended.

If the trailer starts snaking, drive more slowly, do not attempt to correct the steering and brake sharply if necessary.

When driving downhill, drive in the same gear as if driving uphill and drive at a similar speed.

Adjust tyre pressure to the value specified for full load ⇨ 149.

## Trailer towing

### Trailer loads

The permissible trailer loads are vehicle and engine-dependent maximum values which must not be exceeded. The actual trailer load is the difference between the actual gross weight of the trailer and the actual coupling socket load with the trailer coupled.

The permissible trailer loads are specified in the vehicle documents. In general, they are valid for gradients up to max. 12 %.

The permitted trailer loads apply up to the specified incline and up to an altitude of 3300 ft above sea level.

Since engine power decreases as altitude increases due to the air becoming thinner, therefore reducing climbing ability, the permissible gross train weight also decreases by 10 % for every 3300 ft of additional altitude. The gross train weight does not have to be reduced when driving on roads with slight inclines (less than 8 %, e.g. motorways).

The permitted trailer loads apply up to the specified incline and up to an altitude of 1000 metres above sea level. Since engine power decreases as altitude increases due to the air becoming thinner, therefore reducing climbing ability, the permissible gross train weight also decreases by 10 % for every 1000 metres of additional altitude. The gross train weight does

not have to be reduced when driving on roads with slight inclines (less than 8 %, e.g. motorways).

The permissible gross train weight must not be exceeded. This weight is specified on the identification plate ⇨ 139.

### Vertical coupling load

The vertical coupling load is the load exerted by the trailer on the coupling ball. It can be varied by changing the weight distribution when loading the trailer.

The maximum permissible vertical coupling load (50 kg) is specified on the towing equipment identification plate and in the vehicle documents. Always aim for the maximum load, especially in the case of heavy trailers. The vertical coupling load should never fall below 25 kg.

### Rear axle load

The permissible axle loads (see identification plate or vehicle documents) must not be exceeded.

## Vehicle care

|                           |     |
|---------------------------|-----|
| General Information ..... | 99  |
| Vehicle checks .....      | 100 |
| Bulb replacement .....    | 105 |
| Electrical system .....   | 113 |
| Vehicle tools .....       | 118 |
| Wheels and tyres .....    | 119 |
| Jump starting .....       | 129 |
| Towing .....              | 131 |
| Appearance care .....     | 132 |

## General Information

### Accessories and vehicle modifications

We recommend to use genuine parts and accessories and factory approved parts specific for your vehicle type. We cannot assess or guarantee reliability of other products - even if they have a regulatory or otherwise granted approval.

Do not make any modifications to the electrical system, e.g. changes of electronic control units (chip tuning).

### Vehicle storage

#### Storage for a long period of time

Following must be done if the vehicle should be stored for several months:

- Wash and wax the vehicle.
- Have the wax in the engine compartment and underbody checked.
- Clean and preserve rubber seals.
- Change engine oil.

- Drain washer fluid reservoir.
- Check coolant antifreeze and corrosion protection.
- Adjust tyre pressure to the value specified for full load.
- Park vehicle in dry, well ventilated place. Engage first or reverse gear or set selector lever to **P**. Prevent the vehicle from rolling.
- Do not apply parking brake.
- Open bonnet, close all doors and lock the vehicle.
- Disconnect the clamp from the negative terminal of the vehicle battery. Beware that all systems are not functional, e.g. anti-theft alarm system.

#### Putting back into operation

Following must be done if the vehicle is putting back into operation:

- Connect the clamp to the negative terminal of the vehicle battery. Activate the electronics of the power windows.
- Check tyre pressure.
- Fill up the washer fluid reservoir.

- Check the engine oil level.
- Check the coolant level.
- Fit the number plate if necessary.

## End-of-life vehicle recovery

Information on end-of-life vehicle recovery centres and the recycling of end-of-life vehicles is available on our website. Only entrust this work to an authorised recycling centre.

## Vehicle checks

### Performing work

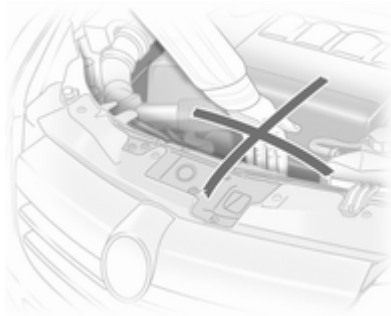

#### **⚠ Warning**

Only perform engine compartment checks when the ignition is off.  
The cooling fan may start operating even if the ignition is off.

#### **⚠ Danger**

The ignition system and Xenon headlights use extremely high voltage. Do not touch.

The caps for topping up the engine oil, the coolant, the washing fluid and the oil dipstick handle are yellow for ease of identification.

## Bonnet

### Opening



Pull the release lever and return it to its original position.

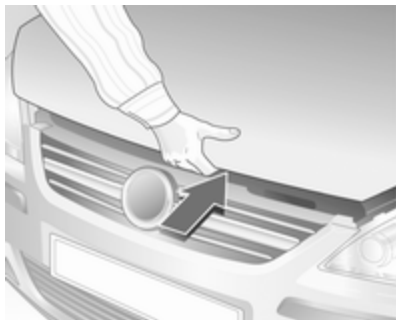

Lift the safety catch upwards and open the bonnet.

Air intake ↪ 82.

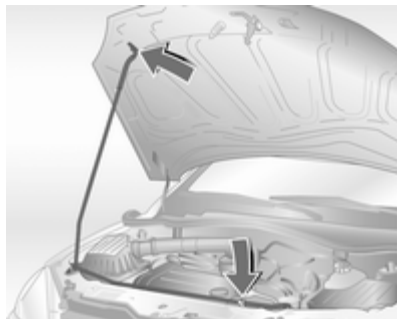

Secure the bonnet support.

### Closing

Before closing the bonnet, press the support into the holder.

Lower the bonnet and allow it to drop into the catch. Check that the bonnet is engaged.

### Engine oil

Check the engine oil level manually on a regular basis to prevent damage to the engine. Ensure that the correct

specification of oil is used. Recommended fluids and lubricants ↪ 136.

Check with the vehicle on a level surface. The engine must be at operating temperature and switched off for at least 5 minutes.

Pull out the dipstick, wipe it clean, insert it to the stop on the handle, pull out and read the engine oil level.

Insert dipstick to the stop on the handle and make half a turn.

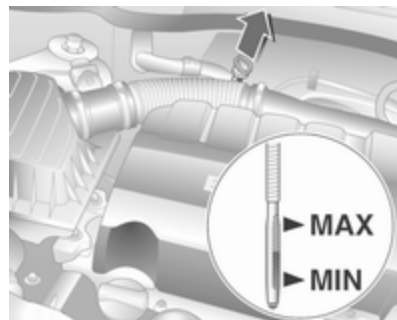

Different dipsticks are used depending on engine variant.

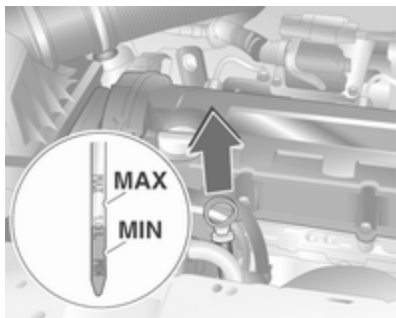

When the engine oil level has dropped to the **MIN** mark, top up engine oil.

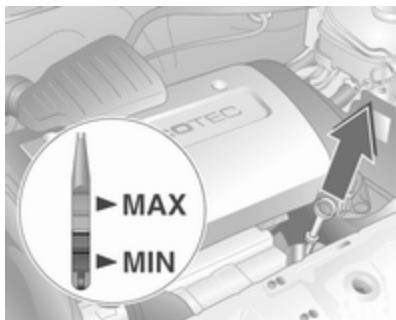

We recommend to use the same engine oil that is filled in.

The engine oil level must not exceed the **MAX** mark on the dipstick.

### Caution

Overfilled engine oil must be drained or suctioned out.

Capacities ⇨ 147.

Fit the cap on straight and tighten it.

## Engine coolant

The coolant provides freeze protection down to approx.  $-28\text{ }^{\circ}\text{C}$ .

### Caution

Only use approved antifreeze.

## Coolant level

### Caution

Too low a coolant level can cause engine damage.

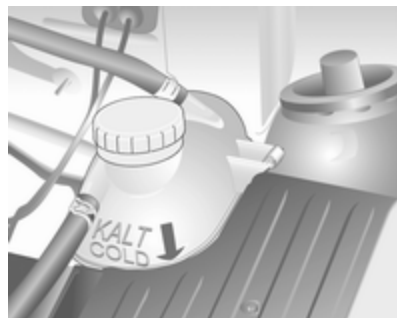

If the cooling system is cold, the coolant level should be above the **KALT/COLD** mark. Top up if the level is low.

### ⚠ Warning

Allow the engine to cool before opening the cap. Carefully open the cap, relieving the pressure slowly.

Top up with antifreeze. If no antifreeze is available, use clean tap water or distilled water. Install the cap tightly. Have the antifreeze

concentration checked and have the cause of the coolant loss remedied by a workshop.

## Washer fluid

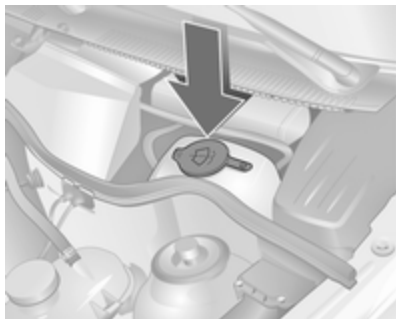

Fill with clean water mixed with a suitable quantity of washer fluid which contains antifreeze. For the correct mixing ratio refer to the washer fluid container.

When closing the reservoir, press the lid firmly over the beaded edge all the way round.

### Caution

Only washer fluid with a sufficient antifreeze concentration provides protection at low temperatures or a sudden drop in temperature.

## Brakes

A squealing noise indicates that the brake lining is at its minimum thickness. Continued driving is possible but have the brake lining replaced as soon as possible.

Once new brake linings are installed, do not brake unnecessarily hard for the first few journeys.

## Brake fluid

### Warning

Brake fluid is poisonous and corrosive. Avoid contact with eyes, skin, fabrics and painted surfaces.

The brake fluid level must be between the **MIN** and the **MAX** marks.

When topping up, ensure maximum cleanliness as contamination of the brake fluid can lead to brake system malfunctions. Have the cause of the loss of brake fluid remedied by a workshop.

Only use high-performance brake fluid approved for the vehicle, Brake and clutch fluid ↗ 136.

## Battery

The vehicle battery is maintenance-free provided that the driving profile allows sufficient charging of the battery. Short distance driving and frequent engine starts can discharge the battery. Avoid the use of unnecessary electrical consumers.



Batteries do not belong in household waste. They must be disposed of at an appropriate recycling collection point.

Laying up the vehicle for more than 4 weeks can lead to battery discharge. Disconnect the clamp from the negative terminal of the vehicle battery.

Ensure the ignition is switched off before connecting or disconnecting the vehicle battery.

The anti-theft alarm siren must be deactivated as follows: switch the ignition on then off, disconnect the vehicle's battery within 15 seconds.

### Replacing the battery

When the battery is being replaced, please ensure that there are no open ventilation holes in the vicinity of the positive terminal. If a ventilation hole is open in this area, it must be closed off with a dummy cap, and the ventilation in the vicinity of the negative terminal must be opened.

Only use batteries that allow the fuse box to be mounted above the battery.

We recommend that you have the battery replaced by a workshop.

### Diesel fuel system bleeding

If the tank has been run dry, the diesel fuel system must be bled. Switch on the ignition three times for 15 seconds at a time. Then crank the engine for a maximum of 40 seconds (For technical reasons only 30 seconds are possible on engine Z 17 DTH). Repeat this process after no less than 5 seconds. If the engine fails to start, seek the assistance of a workshop.

### Wiper blade replacement

#### Wiper blades on the windscreen



Lift wiper arm. Move release lever and detach wiper blade.



## Wiper blade on the rear window

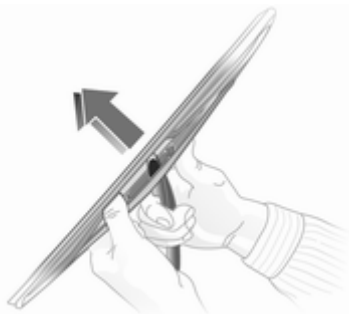

Lift wiper arm. Disengage wiper blade as shown in illustration and remove.

## Bulb replacement

Switch off the ignition and switch off the relevant switch or close the doors.

Only hold a new bulb at the base! Do not touch the bulb glass with bare hands.

Use only the same bulb type for replacement.

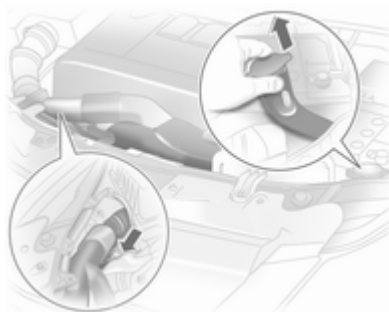

To replace bulbs on the right side of the engine compartment, detach the air hose from the air filter.

To replace the bulb on the left-hand side, remove fuse box cover ⇨ 113. With the Z 13 DTJ engine, also pull

the relay box in front of the fuse box upwards out of the guides. Pull off the air hose on the air filter on the right.

## Halogen headlights

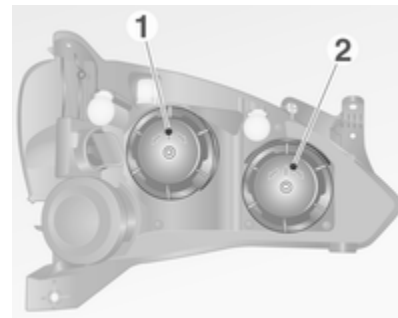

Headlights have separate systems for low beam **1** (outer bulbs) and high beam **2** (inner bulbs).

**Low beam**

1. Rotate the cap anticlockwise and remove.

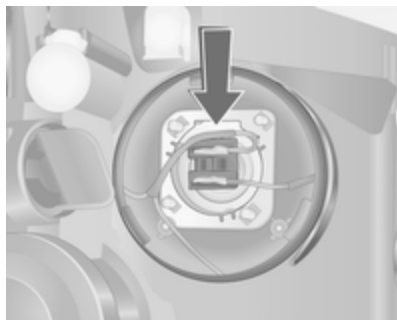

2. Push bulb on plug connector downward.
3. Remove bulb with connector from reflector housing.

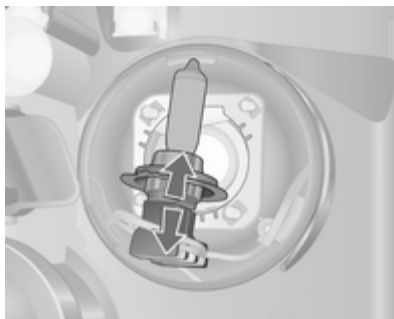

4. Detach plug connector from bulb base.
5. Plug the plug onto the new bulb.
6. Insert the bulb with connector so that the lug engages in the recess in the reflector.
7. Place headlamp protective cover in position and close.

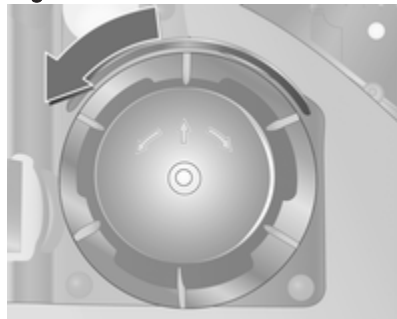
**High beam**

1. Rotate protective cover anticlockwise and remove.
2. Detach plug connector from bulb.



3. Disengage spring clip from retainer by moving it forward and swivelling to the side.
4. Remove bulb from reflector housing.

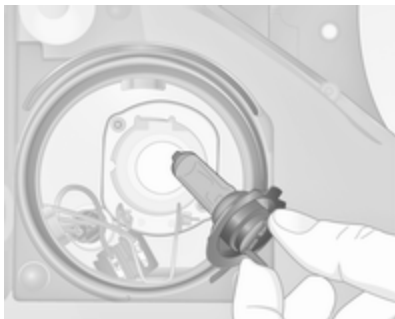

5. When installing the new bulb, insert lugs in the reflector recesses.
6. Install spring clip, plug connector onto bulb.
7. Install protective cover.

### Side lights

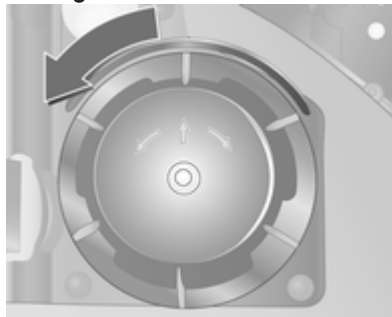

1. Rotate high beam protective cover anticlockwise and remove.
2. Detach plug connector from high beam bulb.

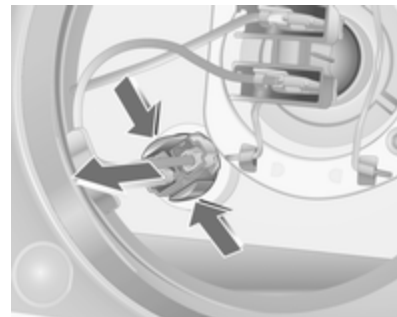

3. Remove bulb from reflector and renew bulb.
4. Insert bulb socket in reflector.

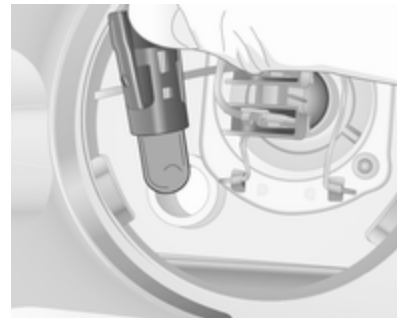

5. Attach connector to main beam bulb.
6. Place protective cover in position and close.

### Ellipsoidal headlights

Headlights have separate systems for low beam (inner bulbs) and high beam (outer bulbs).

#### Low beam

1. Remove protective cover by pressing the catch and pulling the cover downward and off.
2. Detach plug connector from bulb.

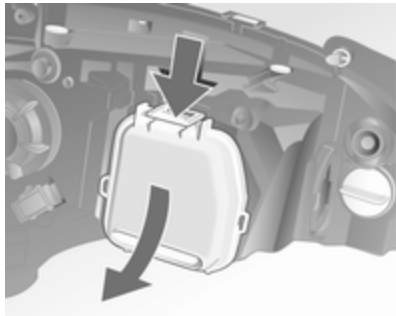

3. Disengage spring clip by swivelling to the side.
4. Remove bulb from reflector housing.

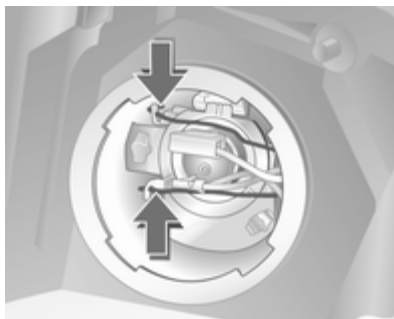

5. When installing the new bulb, insert lugs in the reflector recesses.
6. Install spring clip, plug connector onto bulb.
7. Install protective cover.

#### High beam, parking lights

Have bulbs replaced by a workshop.

### Front turn signal lights

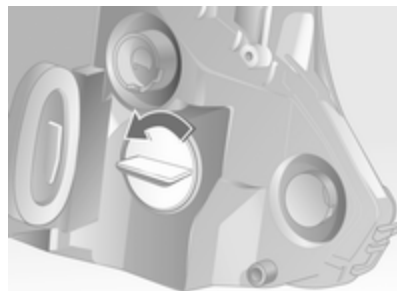

1. Rotate bulb holder anti-clockwise to disengage.
2. Push bulb into socket slightly, rotate anti-clockwise, remove and renew bulb.

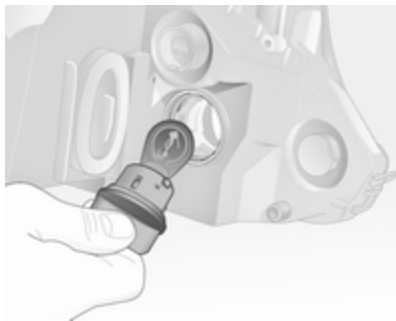

3. Insert bulb holder in reflector, rotate clockwise to engage.

## Fog lights

Have bulbs replaced by a workshop.

## Front turn signal lights

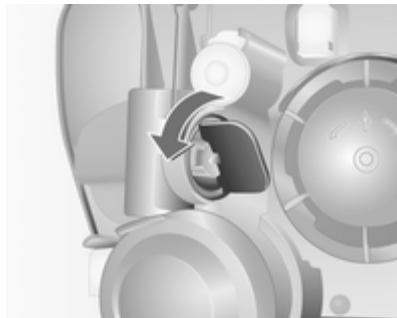

1. Rotate bulb holder anti-clockwise to disengage.

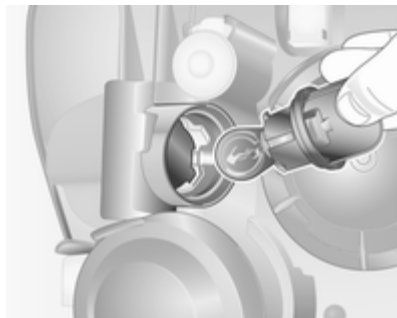

2. Push bulb into socket slightly, rotate anti-clockwise, remove and renew bulb.
3. Insert bulb holder in reflector, rotate clockwise to engage.

## Tail lights

### 5-door passenger vehicle



1. Disengage cover by pressing retaining lugs and remove.



2. Detach plug connector from bulb mounting.
3. Hold bulb housing from the outside; slacken two retaining nuts with the wheel bolt spanner ↻ 118 and unscrew by hand.
4. Detach bulb housing.
5. Press retaining lugs on bulb mounting together and remove bulb mounting



- Bulbs from top to bottom:  
 Reverse light/brake light  
 Turn signal light  
 Reverse light  
 Rear fog light, may be only on one side
6. Remove bulb from socket and renew bulb.
  7. Engage bulb holder in bulb housing. Insert the bulb housing into the vehicle body. Screw the fixing nuts onto setscrews by hand and tighten. Engage the plug connector. Place the cover in position and close.

After bulb replacement, check the tail lights for proper functionality: switch on the ignition, operate the brake, switch on the sidelights.

## Side turn signal lights

Have bulbs replaced by a workshop.

## Number plate light



1. Unscrew both screws. Remove lamp insert.



2. Press bulb slightly towards spring clip and remove.
3. Insert new bulb.
4. Insert lamp insert and secure using a screwdriver.

## Interior lights

### Front courtesy light

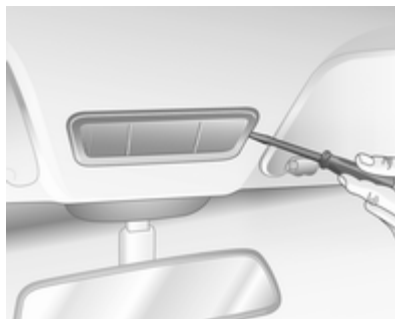

1. Prise lamp out with a screwdriver.
2. Press bulb slightly towards spring clip and remove.

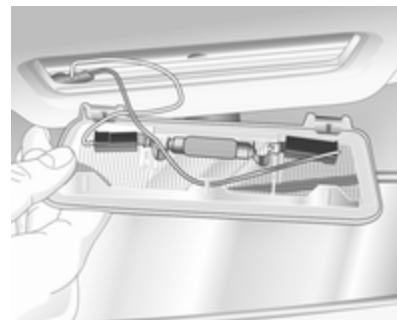

3. Insert new bulb.
4. Mount lens and engage in position.

### Front courtesy light, reading lights



1. Disengage lens using a screwdriver and remove.

2. Remove bulb and renew.



3. Mount lens and engage in position.

### Load compartment light



1. Prise lamp out with a screwdriver.
2. Press bulb slightly towards spring clip and remove.
3. Insert new bulb.
4. Insert lamp in opening and engage in position.

### Instrument panel illumination

Have bulbs replaced by a workshop.



## Electrical system

### Fuses

Data on the replacement fuse must match the data on the defective fuse.

The fuse box is located in the engine compartment.

Before replacing a fuse, turn off the respective switch and the ignition.



A blown fuse can be recognised by its melted wire. Do not replace the fuse until the cause of the fault has been remedied.

Some functions are protected by several fuses.

Fuses may also be inserted without existence of a function.

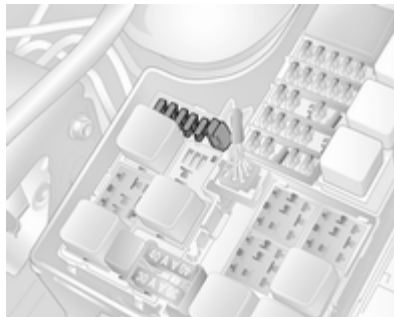

Store spare fuses in the place provided in the fuse box, to the right of which there is a fuse extractor which facilitates fuse replacement.

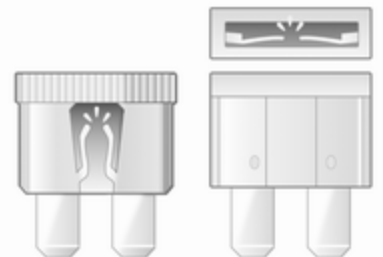

30040

### Engine compartment fuse box

The fuse box is located in the engine compartment next to the coolant expansion tank.

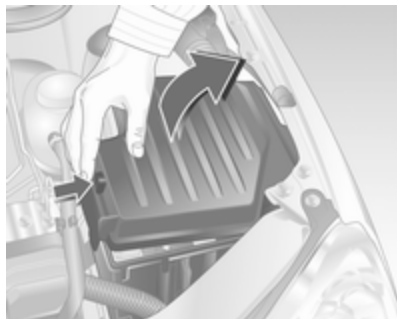

Disengage the cover, lift it upwards and remove.

### Fuse boxes of vehicles with engine Z13DTJ

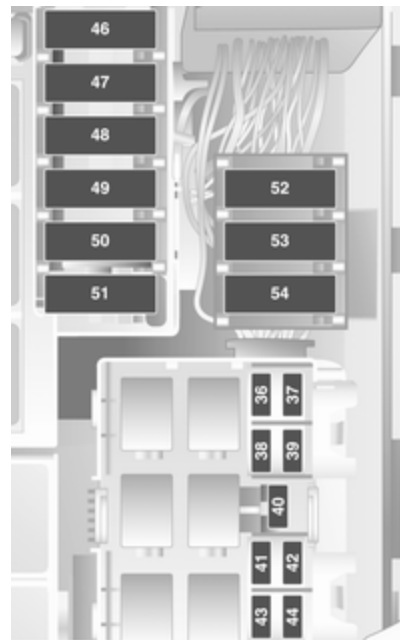

**No. Circuit**

- 1 Central control unit
- 2 Engine control unit
- 3 Instruments, information display, light switch, horn, hazard warning lamps, immobiliser
- 4 Towing equipment, number plate lights
- 5 Power window (left)
- 6 –
- 7 –
- 8 Starter
- 9 Fuel injection system, fuel pump, stationary heater
- 10 Horn
- 11 Central control unit
- 12 Information display, infotainment system
- 13 Anti-theft alarm system

**No. Circuit**

- 14 Exterior mirrors
- 15 Windscreen washer system
- 16 Courtesy light
- 17 Central control unit
- 18 –
- 19 Power window (right)
- 20 –
- 21 –
- 22 Central control unit, immobiliser
- 23 Windscreen wipers
- 24 Infotainment system, information display, light switch, courtesy lamp, instruments, EPS
- 25 Reversing lights, cigarette lighter, power outlet
- 26 Seat heater (right)
- 27 Seat heater (left)

**No. Circuit**

- 28 ABS
- 29 Rear window wiper
- 30 Engine control unit
- 31 Air conditioning system
- 32 ABS, manual transmission automated, airbag
- 33 Engine control
- 34 Diesel filter heater
- 35 Power windows, Infotainment system
- 36 Low beam (left)
- 37 Low beam (right)
- 38 Left tail light, left parking light
- 39 Right tail light, right parking light
- 40 Brake light
- 41 Fog light
- 42 Rear fog light

**No. Circuit**

- 43 High beam (left)
- 44 High beam (right)
- 45 Ventilation fan
- 46 Engine control unit
- 47 Heated rear window
- 48 Starter
- 49 EPS
- 50 ABS
- 51 Petrol engine: manual transmission automated Diesel engine: engine control unit
- 52 Radiator fan
- 53 Cooling fan, air conditioning system
- 54 Manual transmission automated

**Fuse boxes of vehicles with other engines**

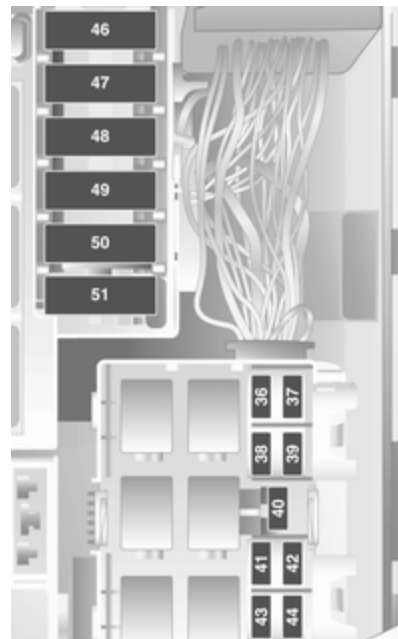

**No. Circuit**

- 1 Central control unit
- 2 Engine control unit
- 3 Instruments, information display, light switch, horn, hazard warning lamps, immobiliser
- 4 Towing equipment, number plate lights
- 5 Power window (left)
- 6 –
- 7 –
- 8 Starter
- 9 Fuel injection system, fuel pump, stationary heater
- 10 Horn
- 11 Central control unit
- 12 Information display, infotainment system
- 13 Anti-theft alarm system

**No. Circuit**

- 14 Exterior mirrors
- 15 Windscreen washer system
- 16 Courtesy light
- 17 Central control unit
- 18 –
- 19 Power window (right)
- 20 –
- 21 –
- 22 Central control unit, immobiliser
- 23 Windscreen wipers
- 24 Infotainment system, information display, light switch, courtesy lamp, instruments, EPS
- 25 Reversing lights, cigarette lighter, power outlet
- 26 Seat heater (right)
- 27 Seat heater (left)

**No. Circuit**

- 28 ABS
- 29 Rear window wiper
- 30 Engine control unit
- 31 Air conditioning system
- 32 ABS, manual transmission automated, airbag
- 33 Engine control
- 34 Diesel filter heater
- 35 Power windows, Infotainment system
- 36 Low beam (left)
- 37 Low beam (right)
- 38 Left tail light, left parking light
- 39 Right tail light, right parking light
- 40 Brake light
- 41 Fog light
- 42 Rear fog light

**No. Circuit**

---

- 43 High beam (left)
- 44 High beam (right)
- 45 Ventilation fan
- 46 Engine control unit
- 47 Heated rear window
- 48 Starter
- 49 EPS
- 50 ABS
- 51 Petrol engine: manual transmission automated Diesel engine: engine control unit
- 52 Radiator fan
- 53 Cooling fan, air conditioning system
- 54 Manual transmission automated

## Vehicle tools

### Tools

#### Combo

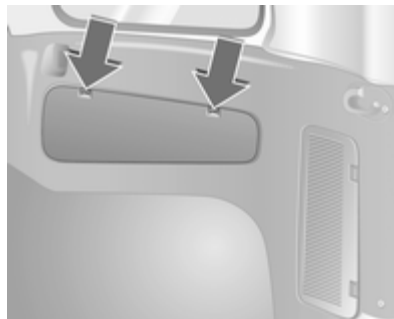

The jack and the vehicle tools are located in a stowage compartment in the side panel trim on the right-hand side.

Release the flap by pressing the retaining lugs.

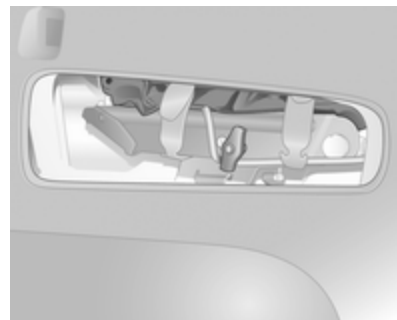

The vehicle tools are secured to the jack with rubber bands.

#### Combo van

The jack and the vehicle tools are secured behind the driver's seat.

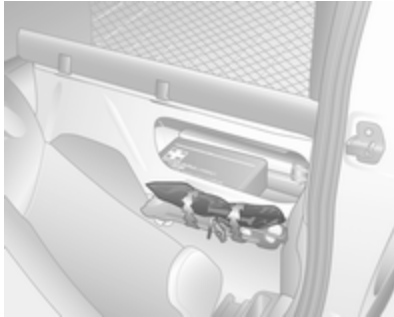

The vehicle tools are secured to the jack with rubber bands.

## Wheels and tyres

### Tyre condition, wheel condition

Drive over edges slowly and at right angles if possible. Driving over sharp edges can cause tyre and wheel damage. Do not trap tyres on the kerb when parking.

Regularly check the wheels for damage. Seek the assistance of a workshop in the event of damage or unusual wear.

### Winter tyres

Winter tyres improve driving safety at temperatures below 7 °C and should therefore be fitted on all wheels.

Tyres of size 175/65 R 14, 175/70 R 14, 185/55 R 15, 185/60 R 15<sup>1)</sup> and 185/65 R 15 are permitted as winter tyres.

In accordance with country-specific regulations, affix the speed sticker in the driver's field of view.

## Tyre designations

E.g. 185/65 R 15 88 T

- 185** = Tyre width, mm
- 65** = Cross-section ratio (tyre height to tyre width), %
- R** = Belt type: Radial
- RF** = Type: RunFlat
- 15** = Wheel diameter, inches
- 88** = Load index e.g. 88 is equivalent to 567 kg
- T** = Speed code letter

Speed code letter:

- Q** = up to 100 mph
- S** = up to 112 mph
- T** = up to 118 mph
- H** = up to 130 mph
- V** = up to 150 mph
- W** = up to 168 mph

- Q** = up to 160 km/h
- S** = up to 180 km/h
- T** = up to 190 km/h
- H** = up to 210 km/h
- V** = up to 240 km/h
- W** = up to 270 km/h

<sup>1)</sup> Not permitted as winter tyres on vehicles with Z13 DTJ.

## Tyre pressure

Check the pressure of cold tyres at least every 14 days and before any long journey. Do not forget the spare wheel. This also applies to vehicles with tyre pressure monitoring system. Remove the valve cap key from the fuel filler flap and use it to unscrew the valve cap.

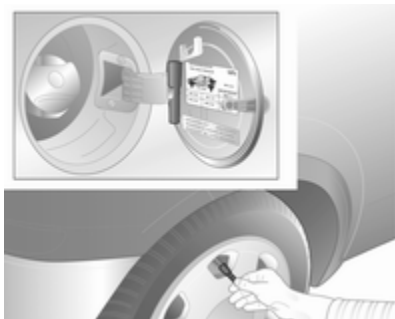

Tyre pressure ↻ 149 and on the label on the inside of the fuel filler flap.

The tyre pressure data refers to cold tyres. It applies to summer and winter tyres.

Always inflate the spare tyre to the pressure specified for full load.

The ECO tyre pressure serves to achieve the smallest amount of fuel consumption possible.

Incorrect tyre pressures will impair safety, vehicle handling, comfort and fuel economy and will increase tyre wear.

### ⚠ Warning

If the pressure is too low, this can result in considerable tyre warm-up and internal damage, leading to tread separation and even to tyre blow-out at high speeds.

## Tread depth

Check tread depth at regular intervals.

Tyres should be replaced for safety reasons at a tread depth of 2-3 mm (4 mm for winter tyres).

The legally permissible minimum tread depth (1.6 mm) has been reached when the tread has worn

down as far as one of the tread wear indicators (TWI). Their position is indicated by markings on the sidewall.

If there is more wear at the front than the rear, swap round front wheels and rear wheels periodically. Ensure that the direction of rotation of the wheels is the same as before.

Tyres age, even if they are not used. We recommend tyre replacement every 6 years.

## Changing tyre and wheel size

If tyres of a different size than those fitted at the factory are used, it may be necessary to reprogram the speedometer and make other vehicle modifications.

After converting to a different tyre size, have the label with tyre pressures replaced.



**⚠ Warning**

Use of unsuitable tyres or wheels may lead to accidents and will invalidate the vehicle type approval.

**Wheel covers**

Wheel covers and tyres that are factory approved for the respective vehicle and comply with all of the relevant wheel and tyre combination requirements must be used.

If the wheel covers and tyres used are not factory approved, the tyres must not have a rim protection ridge.

Wheel covers must not impair brake cooling.

**⚠ Warning**

Use of unsuitable tyres or wheel covers could lead to sudden pressure loss and thereby accidents.

**Tyre chains**

Tyre chains are only permitted on the front wheels.

Always use fine mesh chains that add no more than 10 mm to the tyre tread and the inboard sides (including chain lock).

Remove the wheel covers if fitting tyre chains.

**⚠ Warning**

Damage may lead to tyre blowout.

Tyre chains are just permitted on tyres of size 175/65 R 14, 175/70 R 14 and 185/55 R 15.

Tyre chains are not permitted on tyres with size 185/60 R 15<sup>2)</sup> and 185/65 R 15.

The use of tyre chains is not permitted on the temporary spare wheel.

**Tyre repair kit**

Minor damage to the tyre tread can be repaired with the tyre repair kit.

Do not remove foreign bodies from the tyres.

Tyre damage exceeding 4 mm or that is at tyre's side wall near the rim cannot be repaired with the tyre repair kit.

**⚠ Warning**

Do not drive faster than 50 mph.  
Do not drive faster than 80 km/h.  
Do not use for a lengthy period.  
Steering and handling may be affected.

If you have a flat tyre:

Apply the parking brake and engage first gear, reverse gear.

On the Combo, the tyre repair kit is located behind a cover on the left in the side trim of the luggage

<sup>2)</sup> Only permitted on vehicles with version "increased payload" and/or version "outdoor".

compartment. On the Combo van, it is located in a compartment behind the driver's seat.

To open the compartment, press to release the retaining lugs.

1. Remove bag containing tyre repair kit from compartment. Carefully remove parts from bag.
2. Remove the compressor.

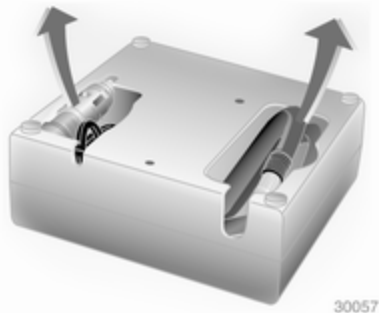

3. Remove the electrical connection cable and air hose from the stowage compartments on the underside of the compressor.



4. Screw the compressor air hose to the connection on the sealant bottle.
5. Fit the sealant bottle in the retainer on the compressor.  
Set the compressor near the tyre in such a way that the sealant bottle is upright.
6. Unscrew valve cap from defective tyre.

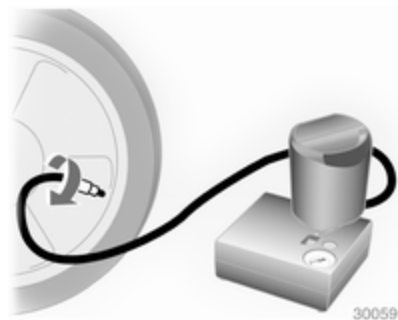

7. Screw tyre inflation hose to valve.
8. The switch on the compressor must be set to  $\text{O}$ .
9. Plug the compressor connector into the accessory socket or the cigarette lighter socket.
10. Switch on ignition.  
To avoid discharging the battery, we recommend running the engine.

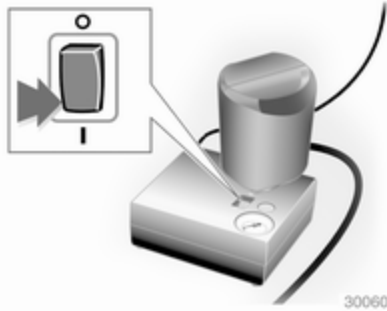

11. Set the rocker switch on the compressor to I. The tyre is filled with sealant.
12. While the sealant bottle drains (approx. 30 seconds) the pressure indicator on the compressor briefly points to 6 bar. Then the pressure starts to drop.  
All of the sealant is pumped into the tyre. Then the tyre is inflated.
13. All of the sealant is pumped into the tyre. Then the tyre is inflated.
14. The prescribed tyre pressure should be obtained within

10 minutes. Tyre pressure  $\varnothing$  149. When the correct pressure is obtained, switch off the compressor.



If the prescribed tyre pressure is not obtained within 10 minutes, remove the tyre repair kit. Move the vehicle one tyre rotation. Reattach the tyre repair kit and continue the filling procedure for 10 minutes. If the prescribed tyre pressure is still not obtained, the tyre is too badly damaged. Seek the assistance of a workshop.

- Release excess tyre pressure with the button over the pressure indicator.
- Do not run the compressor longer than 10 minutes.
15. Detach the tyre repair kit. Screw the filler hose to the free connection on the sealant bottle. This prevents sealant leakage. Stow the tyre repair kit in the load compartment.
  16. Remove any excess sealant using a cloth.
  17. Take the label indicating maximum permitted speed from the sealant bottle and affix in the driver's field of view.
  18. Continue driving immediately so that sealant is evenly distributed in the tyre. After driving approx. 6 miles (but no more than 10 minutes), stop and check tyre pressure. Screw compressor air hose directly onto tyre valve and compressor when doing this.  
Continue driving immediately so that sealant is evenly distributed

in the tyre. After driving approx. 10 km (but no more than 10 minutes), stop and check tyre pressure. Screw compressor air hose directly onto tyre valve and compressor when doing this.

If tyre pressure is more than 1.3 bar, set it to the correct value. Repeat the procedure until there is no more loss of pressure.

If the tyre pressure has fallen below 1.3 bar, the vehicle must not be used. Seek the assistance of a workshop.

19. Stow away tyre repair kit in load compartment.

### Note

The driving characteristics of the repaired tyre is severely affected, therefore have this tyre replaced.

If unusual noise is heard or the compressor becomes hot, turn compressor off for at least 30 minutes.

The built-in safety valve opens at a pressure of 7 bar.

Note the expiry date of the kit. After this date its sealing capability is no longer guaranteed. Pay attention to storage information on sealant bottle.

Replace the used sealant bottle. Dispose of the bottle as prescribed by applicable laws.

The compressor and sealant can be used from approx. -30 °C.

The adapters supplied can be used to pump up other items e.g. footballs, air mattresses, inflatable dinghies etc. They are located on the underside of the compressor. To remove, screw on compressor air hose and withdraw adapter.

## Wheel changing

Some vehicles are equipped with a tyre repair kit instead of a spare wheel ⇨ 121.

Make the following preparations and observe the following information:

- Park the vehicle on a level, firm and non-skid surface. The front wheels must be in the straight-ahead position.
- Apply the parking brake and engage first gear or reverse gear.
- Remove the spare wheel ⇨ 127.
- Never change more than one wheel at once.
- Use the jack only to change wheels.
- If the ground on which the vehicle is standing is soft, a solid board (max. 1 cm thick) should be placed under the jack.

If the ground on which the vehicle is standing is soft, a solid board (max. 0.4 inches thick) should be placed under the jack.

- No people or animals may be in the vehicle when it is jacked-up.

- Never crawl under a jacked-up vehicle.
- Do not start the vehicle when it is raised on the jack.
- Before screwing in the wheel bolts, clean them and lightly coat the taper of each wheel bolt with commercially available grease.

1. Prise off the hub cap using a screwdriver, positioning the screwdriver at the recess at the side of the hub cap. Vehicle tools ⇨ 118.



Pull off the wheel cover with the hook. Vehicle tools ⇨ 118.



On some versions, the wheel cover is removed together with the wheel bolts.

For wheel covers with visible wheel bolts, the cover can remain on the wheel. The retaining rings at the wheel bolts must not be removed.

Alloy wheels: Disengage wheel bolt caps with a screwdriver and remove. To protect the wheel, place a soft cloth between the screwdriver and the alloy wheel.



Alloy wheels with anti-theft lock: unscrew the wheel bolt cap with anti-theft key and remove. Vehicle tools ⇨ 118.

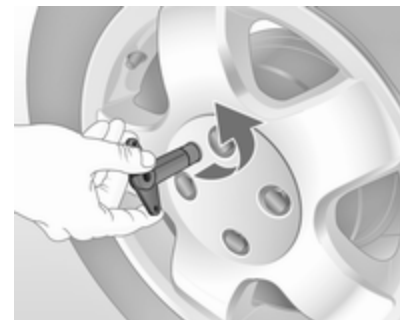

2. Install the wheel wrench ensuring that it locates securely and slacken each bolt by half a turn.

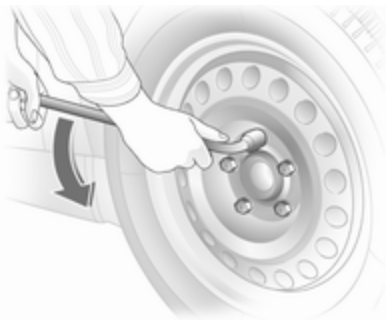

3. Ensure the jack is positioned correctly with the vehicle jacking points.

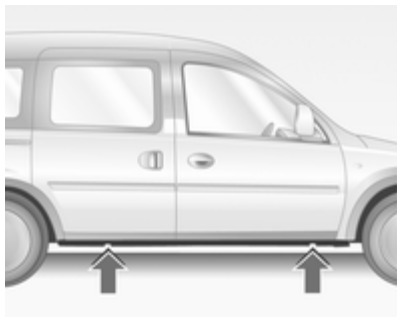

4. Set the jack to the necessary height before positioning it directly below the jacking point in a manner that prevents it from slipping. Position the jack arm so that the jack claw grips the vertical web in the recess.

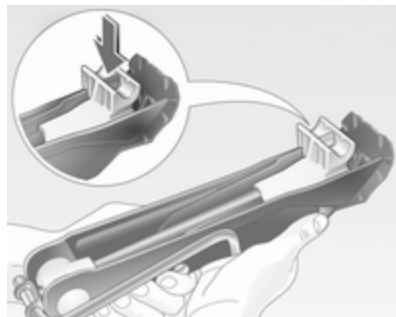

The edge of the jack base must be planted firmly and vertically in line with the contact point. Rotate handle until wheel is clear of the ground.

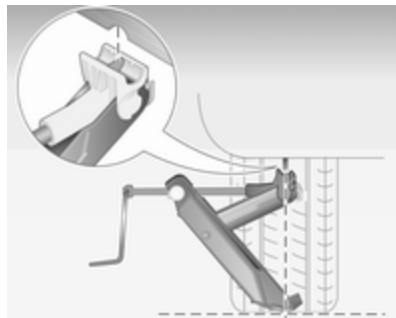

5. Unscrew the wheel bolts.  
If there are lock washers on the wheel bolts, these must not be removed.
6. Change the wheel.
7. Screw in the wheel bolts.
8. Lower vehicle.
9. Install the wheel wrench ensuring that it locates securely and tighten each bolt in a crosswise sequence. Tightening torque is 110 Nm.

Alloy wheels: put wheel bolt cap on and engage, inserting pin on rear of wheel bolt cap into relevant hole in wheel.

Alloy wheels with anti-theft lock: Put wheel bolt cap on. Insert and tighten antitheft lock.

10. Before installing the wheel cover, clean the wheel around the retaining clips. Valve symbol on back of wheel cover must point towards valve on wheel.

Align and engage wheel bolt cap or wheel cover and wheel bolt caps.

11. Stow the replaced wheel ↻ 121 and the vehicle tools ↻ 118.
12. Check the tyre pressure of the installed tyre and also the wheel bolt torque as soon as possible.

Have the defective tyre renewed or repaired.

## Spare wheel

Some vehicles are equipped with a tyre repair kit instead of a spare wheel.

The spare wheel can be classified as a temporary spare wheel depending on the size compared to the other mounted wheels and country regulations.

The spare wheel has a steel rim.

Use of a spare wheel that is smaller than the other wheels or together with winter tyres could affect driveability. Have the defective tyre replaced as soon as possible.

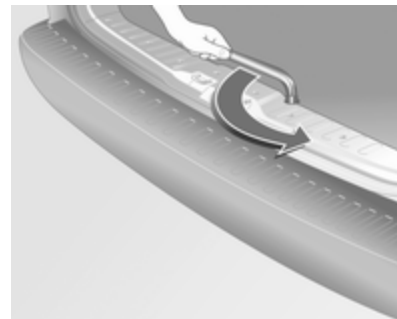

The spare wheel is stored beneath the floor.

1. Fully release the hexagon bolt in the load compartment floor using the wheel bolt wrench. Vehicle tools ↻ 118.
2. Lift the spare wheel holder.
3. Unhook the catch and lower the spare wheel holder.

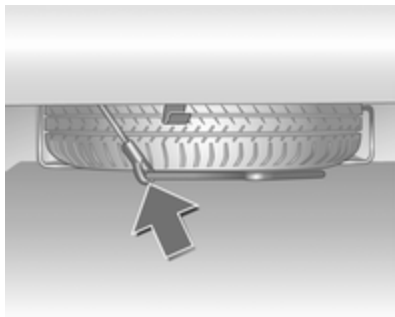

4. Detach the safety cable.
5. Lower the holder fully and take out the spare wheel.

Vehicles with a temporary spare wheel have a spacer ring between the temporary spare and the vehicle underbody.

6. Place the replaced wheel in the spare wheel holder with the outside of the wheel facing upwards.

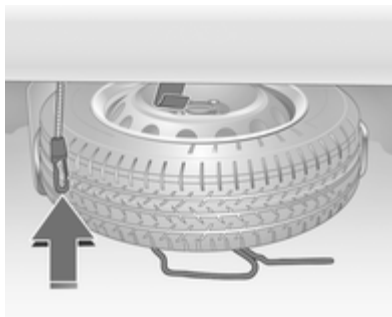

If a full specification wheel is stowed, do not fit the spacer ring between the wheel and the vehicle underbody.

7. Change the wheel.
8. Lift the spare wheel holder, insert the safety cable.
9. Lift the spare wheel holder and engage in the catch. The open side of the catch must point towards the rear.
10. Turn the hexagon bolt in the load compartment floor with the wheel bolt wrench to raise the spare wheel holder all the way up.

### Temporary spare wheel

Use of the temporary spare wheel could affect driveability. Have the defective tyre renewed or repaired as soon as possible.

Only mount one temporary spare wheel. Do not drive faster than 50 mph. Take curves slowly. Do not use for a long period of time.

Only mount one temporary spare wheel. Do not drive faster than 80 km/h. Take curves slowly. Do not use for a long period of time.

If your vehicle gets a flat tyre on the rear while towing another vehicle, mount the temporary spare wheel in the front and the full tyre in the rear. Tyre chains ⇨ 121.

### Directional tyres

Fit directional tyres such that they roll in the direction of travel. The rolling direction is indicated by a symbol (e.g. an arrow) on the sidewall.



The following applies to tyres fitted opposing the rolling direction:

- Driveability may be affected. Have the defective tyre renewed or repaired as soon as possible.
- Drive particularly carefully on wet and snow-covered road surfaces.

## Jump starting

Do not start with quick charger.

A vehicle with a discharged battery can be started using jump leads and the battery of another vehicle.

### Warning

Be extremely careful when starting with jump leads. Any deviation from the following instructions can lead to injuries or damage caused by battery explosion or damage to the electrical systems of both vehicles.

### Warning

Avoid contact of the battery with eyes, skin, fabrics and painted surfaces. The fluid contains sulphuric acid which can cause injuries and damage in the event of direct contact.

- Never expose the battery to naked flames or sparks.

- A discharged battery can already freeze at a temperature of 0 °C. Defrost the frozen battery before connecting jump leads.
- Wear eye protection and protective clothing when handling a battery.
- Use a booster battery with the same voltage (12 Volts). Its capacity (Ah) must not be much less than that of the discharged battery.
- Use jump leads with insulated terminals and a cross section of at least 16 mm<sup>2</sup> (25 mm<sup>2</sup> for diesel engines).
- Do not disconnect the discharged battery from the vehicle.
- Switch off all unnecessary electrical consumers.
- Do not lean over the battery during jump starting.
- Do not allow the terminals of one lead to touch those of the other lead.

- The vehicles must not come into contact with each other during the jump starting process.
- Apply the parking brake, transmission in neutral.

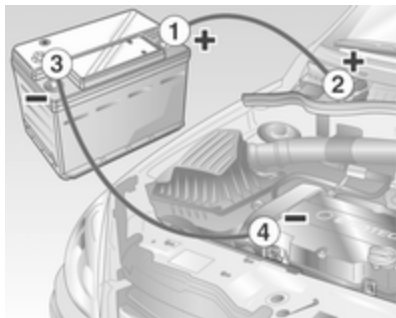

### Lead connection order:

1. Connect the red lead to the positive terminal of the booster battery.
2. Connect the other end of the red lead to the positive terminal of the discharged battery.
3. Connect the black lead to the negative terminal of the booster battery.

4. Connect the other end of the black lead to a vehicle grounding point, such as the engine block or an engine mounting bolt. Connect as far away from the discharged battery as possible, however at least 2 ft.

Connect the other end of the black lead to a vehicle grounding point, such as the engine block or an engine mounting bolt. Connect as far away from the discharged battery as possible, however at least 60 cm.

Route the leads so that they cannot catch on rotating parts in the engine compartment.

### To start the engine:

1. Start the engine of the vehicle providing the jump.
2. After 5 minutes, start the other engine. Start attempts should be made for no longer than 15 seconds at an interval of 1 minute.

3. Allow both engines to idle for approx. 3 minutes with the leads connected.
4. Switch on electrical consumers (e.g. headlights, heated rear window) of the vehicle receiving the jump start.
5. Reverse above sequence exactly when removing leads.

## Towing

### Towing the vehicle



Disengage the cover at the bottom and remove downwards.

The towing eye is stowed with the vehicle tools ↗ 118.

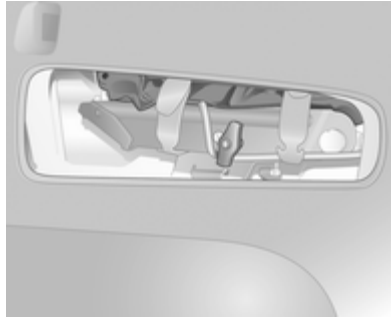

Screw in the towing eye as far as it will go until it stops in a horizontal position.



Attach a tow rope – or better still a tow rod – to the towing eye.

The towing eye must only be used for towing and not recovering the vehicle.

Switch on ignition to release steering wheel lock and to permit operation of brake lights, horn and windscreen wiper.

Transmission in neutral.

Switch on the hazard warning flashers on both vehicles.

#### Caution

Drive slowly. Do not drive jerkily. Excessive tractive force can damage the vehicle.

When the engine is not running, considerably more force is needed to brake and steer.

To prevent the entry of exhaust gases from the towing vehicle, switch on the air recirculation and close the windows.

Seek the assistance of a workshop.

Manual transmission automated  
↪ 89.

After towing, unscrew the towing eye and refit the cover.

## Towing another vehicle

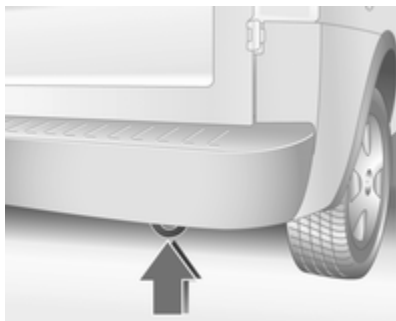

Attach a tow rope – or better still a tow rod – to the rear towing eye on the right side of the vehicle underbody, but never to the rear axle.

The towing eye must only be used for towing and not recovering a vehicle.

### Caution

Drive slowly. Do not drive jerkily. Excessive tractive force can damage the vehicle.

## Appearance care

### Exterior care

#### Locks

The locks are lubricated at the factory using a high quality lock cylinder grease. Use de-icing agent only when absolutely necessary, as this has a degreasing effect and impairs lock function. After using de-icing agent, have the locks regreased by a workshop.

#### Washing

The paintwork of your vehicle is exposed to environmental influences. Wash and wax your vehicle regularly. When using automatic car washes, select a programme that includes waxing.

Bird droppings, dead insects, resin, pollen and the like should be cleaned off immediately, as they contain aggressive constituents which can cause paint damage.

If using a car wash, comply with the car wash manufacturer's instructions. The windscreen wipers and rear window wiper must be switched off. Remove antenna and external accessories such as roof racks etc.

If you wash your vehicle by hand, make sure that the insides of the wheel housings are also thoroughly rinsed out.

Clean edges and folds on opened doors and the bonnet as well as the areas they cover.

Have the door hinges of all doors greased by a workshop.

Do not clean the engine compartment with a steam-jet or high-pressure jet cleaner.

Thoroughly rinse and leather-off the vehicle. Rinse leather frequently. Use separate leathers for painted and glass surfaces: remnants of wax on the windows will impair vision.

Do not use hard objects to remove spots of tar. Use tar removal spray on painted surfaces.

### **Exterior lights**

Headlight and other light covers are made of plastic. Do not use any abrasive or caustic agents, do not use an ice scraper, and do not clean them dry.

### **Polishing and waxing**

Wax the vehicle regularly (at the latest when water no longer beads). Otherwise, the paintwork will dry out.

Polishing is necessary only if the paint has become dull or if solid deposits have become attached to it.

Paintwork polish with silicone forms a protective film, making waxing unnecessary.

Plastic body parts must not be treated with wax or polishing agents.

### **Windows and windscreen wiper blades**

Use a soft lint-free cloth or chamois leather together with window cleaner and insect remover.

When cleaning the rear window, make sure the heating element inside is not damaged.

For mechanical removal of ice, use a sharp-edged ice scraper. Press the scraper firmly against the glass so that no dirt can get under it and scratch the glass.

Clean smearing wiper blades with a soft cloth and window cleaner.

### **Wheels and tyres**

Do not use high-pressure jet cleaners.

Clean rims with a pH-neutral wheel cleaner.

Rims are painted and can be treated with the same agents as the body.

### **Paintwork damage**

Rectify minor paintwork damage with a touch-up pen before rust forms. Have more extensive damage or rust areas repaired by a workshop.

### **Underbody**

Some areas of the vehicle underbody have a PVC undercoating while other critical areas have a durable protective wax coating.

After the underbody is washed, check the underbody and have it waxed if necessary.

Bitumen/rubber materials could damage the PVC coating. Have underbody work carried out by a workshop.

Before and after winter, wash the underbody and have the protective wax coating checked.

### Natural gas system

Do not direct the steam jet or high-pressure jet towards natural gas system components. It is particularly important to protect the natural gas tank and the pressure valves on the vehicle underbody and the bulkhead in the engine compartment.

These components must not be treated using chemical cleaners or preservatives.

Have components of the natural gas system cleaned by a workshop authorised to carry out maintenance of natural gas vehicles.

### Towing equipment

Do not clean the coupling ball bar with a steam-jet or high-pressure jet cleaner.

### Interior care

#### Interior and upholstery

Only clean the vehicle interior, including the instrument panel fascia and panelling, with a dry cloth or interior cleaner.

Clean the leather upholstery with clear water and a soft cloth. In case of heavy soiling, use leather care.

The instrument panel should only be cleaned using a soft damp cloth.

Clean fabric upholstery with a vacuum cleaner and brush. Remove stains with an upholstery cleaner.

Clean seat belts with lukewarm water or interior cleaner.

### Caution

Close Velcro fasteners as open Velcro fasteners on clothing could damage seat upholstery.

### Plastic and rubber parts

Plastic and rubber parts can be cleaned with the same cleaner as used to clean the body. Use interior cleaner if necessary. Do not use any other agent. Avoid solvents and petrol in particular. Do not use high-pressure jet cleaners.

## Service and maintenance

|  |     |
|--|-----|
| General information .....                      | 135 |
| Recommended fluids, lubricants and parts ..... | 136 |

## General information

### Service information

In order to ensure economical and safe vehicle operation and to maintain the value of your vehicle, it is of vital importance that all maintenance work is carried out at the proper intervals as specified.

The detailed, up-to-date service schedule for your vehicle is available at the workshop.

### European service intervals

Service is due every 20,000 miles or 1 year, whichever occurs first.

Service is due every 30.000 km or 1 year, whichever occurs first.

The European schedule is valid for the following countries:

Andorra, Austria, Belgium, Bosnia-Herzegovina, Bulgaria, Croatia, Cyprus, Czech Republic, Denmark, Estonia, Finland, France, Germany, Greece, Greenland, Hungary, Iceland, Ireland, Italy, Latvia, Lithuania, Luxembourg, Macedonia,

Malta, Montenegro, the Netherlands, Norway, Poland, Portugal, Romania, Serbia, Slovakia, Slovenia, Spain, Sweden, Switzerland, United Kingdom.

### International service intervals

Service is due every 10,000 miles or 1 year, whichever occurs first.

Service is due every 15.000 km or 1 year, whichever occurs first.

The international service intervals are valid for the countries which are not listed at the european service intervals.

### Confirmations

Confirmation of service is recorded in the Service and Warranty Booklet.

The date and mileage is completed with the stamp and signature of the servicing workshop.

Make sure that the Service and Warranty Booklet is completed correctly as continuous proof of service is essential if any warranty or

goodwill claims are to be met, and is also a benefit when selling the vehicle.

### Fixed service interval

When service is due, **InSP** appears in the odometer display for approximately 10 seconds when the ignition is switched on. Have the next service performed by a workshop within one week or 300 miles (whichever occurs first).

When service is due, **InSP** appears in the odometer display for approximately 10 seconds when the ignition is switched on. Have the next service performed by a workshop within one week or 500 km (whichever occurs first).

### Flexible service interval

The service interval is based on several parameters depending on usage and calculated using these parameters.

If the remaining distance is less than 1000 miles, **InSP** is displayed with a remaining distance of 600 miles when the ignition is switched on and

off. If less than 600 miles remain, **InSP** is displayed for several seconds. Have the next service performed by a workshop within one week or 300 miles (whichever occurs first).

If the remaining distance is less than 1500 km, **InSP** is displayed with a remaining distance of 1000 km when the ignition is switched on and off. If less than 1000 km remain, **InSP** is displayed for several seconds. Have the next service performed by a workshop within one week or 500 km (whichever occurs first).

Display of remaining distance:

1. Switch off ignition.
2. Briefly press the trip odometer reset button. The odometer reading is shown.
3. Press and hold the reset button for approx. 2 seconds. **InSP** and the remaining distance are displayed.

## Recommended fluids, lubricants and parts

### Recommended fluids and lubricants

Only use products that have been tested and approved. Damage resulting from the use of non-approved materials will not be covered by the warranty.

#### Warning

Operating materials are hazardous and could be poisonous. Handle with care. Pay attention to information given on the containers.

### Engine oil

Engine oil is identified by its quality and its viscosity. Quality is more important than viscosity when selecting which engine oil to use. The oil quality ensures e.g. engine cleanliness, wear protection and oil



aging control, whereas viscosity grade gives information on the oil's thickness over a temperature range.

The new engine oil quality Dexos 2™ is the newest oil quality and combines gasoline and diesel performance. If it is unavailable, engine oils of other listed qualities have to be used.

#### Engine oil quality for European service schedules

Dexos 2™ = All petrol and diesel engines

Alternative qualities if Dexos 2™ is not available:

GM-LL-A-025 = Petrol engines  
GM-LL-B-025 = Diesel engines

#### Engine oil quality for international service schedules

Dexos 2™ = All petrol and diesel engines

Alternative qualities if Dexos 2™ is not available:

GM-LL-A-025 = Petrol engines  
GM-LL-B-025 = Diesel engines

Alternative qualities if GM-LL-A-025 or GM-LL-B-025 are not available:

ACEA-A3/B3 or = Petrol engines  
A3/B4  
ACEA-A3/B4 = Diesel engines  
without Diesel  
Particle Filter  
(DPF)  
ACEA-C3 = Diesel engines  
with DPF

#### Topping up engine oil

Engine oils of different manufacturers and brands can be mixed as long as they comply with the required engine oil quality and viscosity.

If engine oil of the required quality is not available, a maximum of 1 litre of ACEA C3 grade may be used (only once between each oil change). The viscosity should be of one of the below listed viscosity grades.

Use of engine oil with only ACEA A1/B1 or only A5/B5 quality is explicitly prohibited, since it can cause long-term engine damage under certain operating conditions.

#### Additional engine oil additives

The use of additional engine oil additives could cause damage and invalidate the warranty.

#### Engine oil viscosity grades

Use only engine oil viscosity grades SAE 5W-30 or 5W-40, 0W-30 or 0W-40.

The SAE viscosity grade gives information of the thickness of the oil.

Multigrade oil is indicated by two figures. The first figure, followed by a W, indicates the low temperature viscosity and the second figure the high temperature viscosity. Please select the appropriate viscosity grade depending on your minimum ambient temperature.

- down to -25°C:  
SAE 5W-30 or SAE 5W-40
- below -25°C:  
SAE 0W-30 or SAE 0W-40

#### Coolant and antifreeze

Use only silicate-free long life coolant (LLC) antifreeze.

The system is factory filled with coolant designed for excellent corrosion protection and frost protection down to approx.  $-28^{\circ}\text{C}$ . This concentration should be maintained all year round. The use of additional coolant additives that intend to give additional corrosion protection or seal against minor leaks can cause function problems. Liability for consequences resulting from the use of additional coolant additives will be rejected.

### **Brake and clutch fluid**

Use only brake fluid which exceeds DOT4 requirements.

Over time, brake fluid absorbs moisture which will reduce braking effectiveness. The brake fluid should therefore be replaced at the specified interval.

Brake fluid should be stored in a sealed container to avoid water absorption.

Ensure brake fluid does not become contaminated.

## Technical data

|                              |     |
|------------------------------|-----|
| Vehicle identification ..... | 139 |
| Vehicle data .....           | 141 |

## Vehicle identification

### Vehicle Identification Number



The Vehicle Identification Number is stamped on the identification plate and on the floor pan, under the floor covering, visible under a cover.

The Vehicle Identification Number may be embossed on the instrument panel visible through the windscreen.

## Identification plate



The identification plate is located on the front right door frame.



In other versions the type plate is attached to the right spring strut dome in the engine compartment.



Information on identification plate:

- 1 = Manufacturer
- 2 = Type approval number
- 3 = Vehicle Identification Number
- 4 = Permissible gross vehicle weight rating
- 5 = Permissible gross train weight
- 6 = Maximum permissible front axle load
- 7 = Maximum permissible rear axle load
- 8 = Vehicle-specific or countryspecific data

The combined total of front and rear axle loads must not exceed the permissible gross vehicle weight. For example, if the front axle is bearing its maximum permissible load, the rear axle can only bear a load that is equal to the gross vehicle weight minus the front axle load.

The technical data is determined in accordance with European Community standards. We reserve the right to make modifications. Specifications in the vehicle documents always have priority over those given in this manual.

## Vehicle data

### Engine data

| Sales designation                      | 1.4 Twinport | CNG                | 1.3 CDTI     | 1.7 CDTI |
|--|--------------|--------------------|--------------|----------|
| Engine identifier code                 | Z 14 XEP     | Z 16 YNG           | Z 13 DTJ     | Z 17 DTH |
| Number of cylinders                    | 4            | 4                  | 4            | 4        |
| Piston displacement [cm <sup>3</sup> ] | 1364         | 1598               | 1248         | 1686     |
| Engine power [kW]                      | 66           | 69                 | 55           | 74       |
| at rpm                                 | 5600         | 6200               | 4000         | 4400     |
| Torque [Nm]                            | 125          | 133                | 170          | 240      |
| at rpm                                 | 4000         | 4200               | 1750 to 2500 | 2300     |
| Fuel type                              | Petrol       | Natural gas/petrol | Diesel       | Diesel   |
| Octane rating [RON]                    |              |                    |              |          |
| recommended                            | <b>95</b>    | <b>Natural gas</b> | –            | –        |
| possible                               | 98           | 95                 | –            | –        |
| possible                               | 91           | 91                 | –            | –        |
| Oil consumption [l/1000 km]            | 0.6          | 0.6                | 0.6          | 0.6      |

## Performance

| Engine                            | Z 14 XEP | Z 16 YNG | Z 13 DTJ         | Z 17 DTH |
|-----------------------------------|----------|----------|------------------|----------|
| Maximum speed <sup>1)</sup> [mph] |          |          |                  |          |
| 5-speed manual transmission       | 102      | 103      | 94 <sup>2)</sup> | 106      |
| Manual transmission automated     | –        | –        | 94 <sup>2)</sup> | –        |

| Engine                             | Z 14 XEP | Z 16 YNG | Z 13 DTJ          | Z 17 DTH |
|------------------------------------|----------|----------|-------------------|----------|
| Maximum speed <sup>3)</sup> [km/h] |          |          |                   |          |
| 5-speed manual transmission        | 164      | 165      | 152 <sup>4)</sup> | 170      |
| Manual transmission automated      | –        | –        | 152 <sup>4)</sup> | –        |

## Fuel consumption - CO<sub>2</sub>-emissions

To convert l/100 km into mpg, divide 282 by number of litres/100 km.

- 1) The maximum speed indicated is achievable at kerb weight (without driver) plus 200 kg payload. Optional equipment could reduce the specified maximum speed of the vehicle.
- 2) Specific version with electronic speed limitation at 78 mph.
- 3) The maximum speed indicated is achievable at kerb weight (without driver) plus 200 kg payload. Optional equipment could reduce the specified maximum speed of the vehicle.
- 4) Specific version with electronic speed limitation at 125 km/h.

---

 Tyre width up to 185 mm

| <b>Engine</b>                        | <b>Z 14 XEP</b> | <b>Z 13 DTJ</b> | <b>Z 17 DTH</b> |
|--------------------------------------|-----------------|-----------------|-----------------|
| Manual/manual transmission automated |                 |                 |                 |
| urban [l/100 km]                     | 7.9 / –         | 6.1 / 5.9       | 6.6 / –         |
| extra-urban [l/100 km]               | 5.2 / –         | 4.5 / 4.5       | 4.4 / –         |
| total [l/100 km]                     | 6.2 / –         | 5.1 / 5.0       | 5.2 / –         |
| CO <sub>2</sub> [g/km]               | 148 / –         | 134 / 135       | 140 / –         |

---

 Tyre width up to 205 mm

| <b>Engine</b>                        | <b>Z 14 XEP</b> | <b>Z 13 DTJ</b> | <b>Z 17 DTH</b> |
|--------------------------------------|-----------------|-----------------|-----------------|
| Manual/manual transmission automated |                 |                 |                 |
| urban [l/100 km]                     | 8.1 / –         | 6.3 / 6.1       | 6.8 / –         |
| extra-urban [l/100 km]               | 5.4 / –         | 4.7 / 4.7       | 4.6 / –         |
| total [l/100 km]                     | 6.4 / –         | 5.3 / 5.2       | 5.4 / –         |
| CO <sub>2</sub> [g/km]               | 153 / –         | 139 / 140       | 146 / –         |

---

| Engine   | Z 16 YNG   |
|--|------------|
| Manual transmission                                |            |
| urban [m <sup>3</sup> /100 km] / [kg/100 km]       | 10.1 / 6.6 |
| extra-urban [m <sup>3</sup> /100 km] / [kg/100 km] | 5.9 / 3.9  |
| total [m <sup>3</sup> /100 km] / [kg/100 km]       | 7.5 / 4.9  |
| CO <sub>2</sub> [g/km]                             | 133        |

## Vehicle weight

### Kerb weight

| Combo van   | Engine   | Manual transmission | Manual transmission automated |
|---|----------|---------------------|-------------------------------|
| without/with air conditioning/climate control<br>[kg] | Z 14 XEP | 1190 / 1350         | –                             |
|   | Z 16 YNG | 1322 / 1352         | –                             |
|   | Z 13 DTJ | 1285 / 1420         | 1285 / 1420                   |
|   | Z 17 DTH | 1320 / 1455         | –                             |



| Combo   | Engine   | Manual transmission | Manual transmission automated |
|---|----------|---------------------|-------------------------------|
| without/with air conditioning/climate control<br>[kg] | Z 14 XEP | 1235 / 1265         | –                             |
|   | Z 16 YNG | 1367 / 1397         | –                             |
|   | Z 13 DTJ | 1325 / 1355         | 1325 / 1355                   |
|   | Z 17 DTH | 1365 / 1395         | –                             |

### Heavy accessories

| Accessories | Folding sun roof | Towing equipment | Anti-lock braking system (ABS) | Sliding door (front passenger's side) | Rear vent windows | Load compartment grille | Split load compartment grille |
|-------------|------------------|------------------|--------------------------------|---------------------------------------|-------------------|-------------------------|-------------------------------|
| Weight [kg] | 18               | 18               | 7                              | 23                                    | 9                 | 8                       | 10                            |

### Vehicle dimensions

|                                      | Combo van | Combo |
|--------------------------------------|-----------|-------|
| Overall length [mm]                  | 4322      | 4322  |
| Overall width [mm]                   | 1684      | 1684  |
| Width with two exterior mirrors [mm] | 1892      | 1892  |
| Height at kerb weight [mm]           | 1801      | 1801  |

|  | Combo van                               | Combo  |
|--|---|--|
| Length of load compartment floor [mm]                                  | 1787 <sup>5)</sup> / 2700 <sup>6)</sup> | 1020 <sup>7)</sup> / 1664 <sup>8)</sup> / 2700 <sup>6)</sup> |
| Load compartment width [mm]<br>without / with 1 / with 2 sliding doors | 1348 / 1399 / 1449                      | – / 1399 / 1449  |
| min. width between wheel housing                                       | 1107                                    | 1107   |
| Load compartment height [mm]   | 1190                                    | 1190   |
| Load compartment sill height [mm]                                      | 550                                     | 550  |
| Opening width, tailgate min./max. [mm]                                 | 1030 / 1210                             | 1030 / 1210  |
| Opening height, tailgate min./max. [mm]                                | 1120 / 1139                             | 1120 / 1139  |
| Opening width of sliding door [mm]                                     | 620                                     | 620  |
| Opening height of sliding door [mm]                                    | 913                                     | 1023   |
| Wheelbase [mm]   | 2716                                    | 2716   |
| Turning circle diameter [m]  | 11.25                                   | 11.25  |

5) behind the front seats.

6) with front passenger seat folded down.

7) behind the rear seats.

8) with the backrests folded down.

---

## Capacities

### Engine oil

| Engine                  | Z 14 XEP | Z 13 DTJ | Z 17 DTH |
|-------------------------|----------|----------|----------|
| including Filter [l]    | 3.5      | 3.5      | 5.0      |
| Between MIN and MAX [l] | 1.0      | 1.0      | 1.0      |

### Fuel tank

| Engine                              | Z 14 XEP | Z 13 DTJ | Z 17 DTH |
|-------------------------------------|----------|----------|----------|
| Petrol/diesel, nominal capacity [l] | 52       | 52       | 52       |

### Engine oil

| Engine                  | Z 16 YNG |
|-------------------------|----------|
| including Filter [l]    | 3.5      |
| Between MIN and MAX [l] | 1.0      |

---

**Fuel tank****Engine****Z 16 YNG**

---

Natural gas, nominal capacity[kg]

17.5<sup>9)</sup>

petrol, nominal capacity [l]

14

---

<sup>9)</sup> 17.5 kg (average fill limit), corresponding to a tank volume of 108 l. Fill weight in kg is dependent on outside temperature, filling pressure and type of tank system.

## Tyre pressures

| Combo van |                                | Comfort with up to 2 people and<br>100 kg luggage |                   | With full load    |                   |
|-----------|--------------------------------|---|-------------------|-------------------|-------------------|
|           |                                | front   | rear              | front             | rear              |
| Engine    | Tyres                          | [kPa/bar] ([psi])                                 | [kPa/bar] ([psi]) | [kPa/bar] ([psi]) | [kPa/bar] ([psi]) |
| Z 14 XEP  | 175/70 R 14, <sup>10)11)</sup> | 240 / 2.4 (35)                                    | 240 / 2.4 (35)    | 240 / 2.4<br>(35) | 350 / 3.5<br>(51) |
|           | 175/65 R 14, <sup>11)</sup>    |   |                   |                   |                   |
|           | 185/55 R 15, <sup>12)13)</sup> |   |                   |                   |                   |
|           | 185/60 R 15                    |   |                   |                   |                   |
| Z 13 DTJ  | 175/70 R 14, <sup>10)11)</sup> | 240 / 2.4 (35)                                    | 240 / 2.4 (35)    | 240 / 2.4<br>(35) | 350 / 3.5<br>(51) |
|           | 175/65 R 14, <sup>11)</sup>    |   |                   |                   |                   |
|           | 185/55 R 15, <sup>12)13)</sup> |   |                   |                   |                   |
|           | 185/60 R 15                    |   |                   |                   |                   |
| Z 17 DTH  | 185/60 R 15,                   | 240 / 2.4 (35)                                    | 240 / 2.4 (35)    | 240 / 2.4<br>(35) | 350 / 3.5<br>(51) |
|           | 185/55 R 15 <sup>13)</sup>     |   |                   |                   |                   |

<sup>10)</sup> Recommendation: Dunlop SP 10, Firestone F 580, Pirelli P 3000.

<sup>11)</sup> Not permitted in version with "increased payload".

<sup>12)</sup> Only permitted in version with "increased payload".

<sup>13)</sup> Recommended winter tyres: Conti Vanco Winter C90Q.

| Combo van |  | Comfort with up to 2 people and<br>100 kg luggage |                   | With full load       |                      |
|-----------|--|---|-------------------|----------------------|----------------------|
|           |  | front   | rear              | front                | rear                 |
| Engine    | Tyres  | [kPa/bar] ([psi])                                 | [kPa/bar] ([psi]) | [kPa/bar]<br>([psi]) | [kPa/bar]<br>([psi]) |
| Z 16 YNG  | 185/60 R 15,<br>185/55 R 15 <sup>13)</sup>                         | 240 / 2.4 (35)                                    | 240 / 2.4 (35)    | 240 / 2.4<br>(35)    | 350 / 3.5<br>(51)    |
| all       | T 115/70 R 16 (Temporary spare<br>wheel) <sup>14)</sup> ↔ 121, 127 | 420 / 4.2 (61)                                    | 420 / 4.2 (61)    | 420 / 4.2<br>(61)    | 420 / 4.2<br>(61)    |

<sup>13)</sup> Recommended winter tyres: Conti Vanco Winter C90Q.

<sup>14)</sup> Notes on temporary spare wheel.

| Combo<br>Engine | Tyres   | Comfort with up to 3 people |                   | With full load    |                   |
|-----------------|---|-----------------------------|-------------------|-------------------|-------------------|
|                 |   | front                       | rear              | front             | rear              |
|                 |   | [kPa/bar] ([psi])           | [kPa/bar] ([psi]) | [kPa/bar] ([psi]) | [kPa/bar] ([psi]) |
| Z 14 XEP        | 175/70 R 14, <sup>15)</sup><br>175/65 R 14,<br>185/55 R 15, <sup>16)17)</sup><br>185/60 R 15, <sup>18)</sup><br>185/65 R 15,<br>195/45 R 16,<br>195/50 R 16 | 240 / 2.4 (35)              | 240 / 2.4 (35)    | 240 / 2.4 (35)    | 350 / 3.5 (51)    |
| Z 13 DTJ        | 175/70 R 14, <sup>15)</sup><br>175/65 R 14,<br>185/55 R 15, <sup>16)17)</sup><br>185/60 R 15,<br>185/65 R 15  | 240 / 2.4 (35)              | 240 / 2.4 (35)    | 240 / 2.4 (35)    | 350 / 3.5 (51)    |

<sup>15)</sup> Recommendation: Michelin Agilis 41, Continental VancoContact.

<sup>16)</sup> Only permitted in version with "increased payload".

<sup>17)</sup> Recommended: Conti C90Q.

<sup>18)</sup> Recommended: Pirelli P 6000, Continental CPC, Goodyear NCT5, Dunlop SP 01.

## 152 Technical data

| Combo<br>Engine | Tyres  | Comfort with up to 3 people |                           | With full load             |                           |
|-----------------|--|-----------------------------|---------------------------|----------------------------|---------------------------|
|                 |  | front<br>[kPa/bar] ([psi])  | rear<br>[kPa/bar] ([psi]) | front<br>[kPa/bar] ([psi]) | rear<br>[kPa/bar] ([psi]) |
| Z 17 DTH        | 185/60 R 15,<br>185/55 R 15, <sup>17)</sup><br>185/65 R 15,<br>195/50 R 16 | 240 / 2.4 (35)              | 240 / 2.4 (35)            | 240 / 2.4 (35)             | 350 / 3.5 (51)            |
| Z 16 YNG        | 185/60 R 15,<br>185/55 R 15, <sup>17)</sup><br>185/65 R 15                 | 240 / 2.4 (35)              | 240 / 2.4 (35)            | 240 / 2.4 (35)             | 350 / 3.5 (51)            |
| all             | T 115/70 R 16 (Temporary spare wheel) <sup>14)</sup>                       | 420 / 4.2 (61)              | 420 / 4.2 (61)            | 420 / 4.2 (61)             | 420 / 4.2 (61)            |

<sup>17)</sup> Recommended: Conti C90Q.

<sup>14)</sup> Notes on temporary spare wheel.



| Combo Tramp / Arizona |                            | Comfort with up to 3 people |                   | With full load    |                   |
|-----------------------|----------------------------|-----------------------------|-------------------|-------------------|-------------------|
| Engine                | Tyres                      | front                       | rear              | front             | rear              |
|                       |                            | [kPa/bar] ([psi])           | [kPa/bar] ([psi]) | [kPa/bar] ([psi]) | [kPa/bar] ([psi]) |
| Z 14 XEP              | 185/60 R15                 | 240 / 2.4 (35)              | 240 / 2.4 (35)    | 240 / 2.4 (35)    | 350 / 3.5 (51)    |
| Z 16 YNG              | 185/65 R 15 <sup>19)</sup> |                             |                   |                   |                   |
| Z 13 DTJ              |                            |                             |                   |                   |                   |
| Z 17 DTH              |                            |                             |                   |                   |                   |

<sup>19)</sup> Recommended: Goodyear Eagle Hydragrip.

## Towing hitch installation dimensions

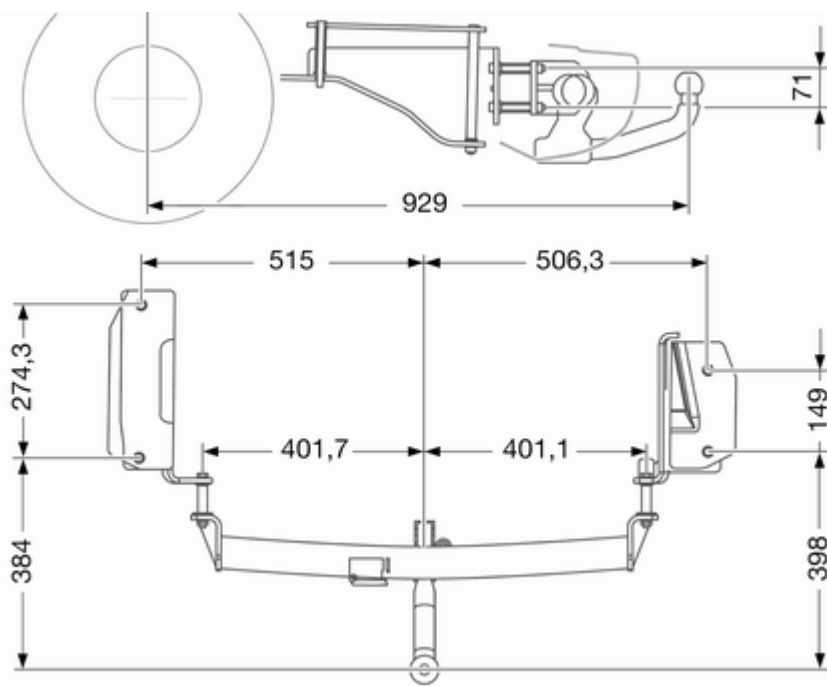

## Customer information

Vehicle data recording and  
privacy ..... 155

### Vehicle data recording and privacy

#### Event data recorders

The vehicle has a number of sophisticated systems that monitor and control several vehicle data. Some data may be stored during regular operation to facilitate repair of detected malfunctions, other data is stored only in a crash or near crash event by systems commonly called event data recorders (EDR).

The systems may record data about the condition of the vehicle and how it was operated (e.g. engine speed, brake application, seat belt usage). To read this data special equipment and access to the vehicle is required. This will take place when the vehicle is serviced in a workshop. Some data is electronically fed into GM global diagnostic systems. The manufacturer will not access information about a crash event or share it with others except

- with the consent of the vehicle owner or, if the vehicle is leased, with the consent of the lessee,
- in response to an official request of police or similar government office,
- as part of the manufacturer's defense in case of legal proceedings,
- as required by law.

In addition, the manufacturer may use the collected or received data

- for the manufacturer's research needs,
- to make it available for research needs where appropriate confidentiality is maintained and need is shown,
- to share summary data which is not tied to a specific vehicle with other organisations for research purposes.

# Index

- A**
- Accessories and vehicle modifications ..... 99
  - Adjustable air vents ..... 82
  - Airbag and belt tensioners ..... 67
  - Airbag system ..... 39
  - Air conditioning regular operation 83
  - Air conditioning system ..... 81
  - Air intake ..... 82
  - Antilock brake system ..... 92
  - Antilock brake system (ABS) ..... 68
  - Anti-theft alarm system ..... 25
  - Ashtrays ..... 60
- B**
- Battery ..... 103
  - Battery discharge protection ..... 79
  - Bonnet ..... 100
  - Brake and clutch fluid..... 136
  - Brake and clutch system ..... 68
  - Brake assist ..... 94
  - Brake fluid ..... 103
  - Brakes ..... 92, 103
  - Bulb replacement ..... 105
- C**
- Capacities ..... 147
  - Car Pass ..... 17
  - Catalytic converter ..... 87
  - Central locking system ..... 19
  - Centre console lighting ..... 79
  - Centre console storage ..... 48
  - Changing tyre and wheel size ... 120
  - Charging system ..... 67
  - Child locks ..... 23
  - Child restraint installation locations ..... 43
  - Child restraint systems ..... 41
  - Cigarette lighter ..... 59
  - Climate control ..... 14
  - Clock ..... 59
  - Control indicators..... 65
  - Control of the vehicle ..... 84
  - Convex shape ..... 29
  - Coolant and antifreeze..... 136
- D**
- Danger, Warnings and Cautions ... 4
  - Diesel fuel system bleeding ..... 104
  - Diesel particle filter ..... 86
  - Driving characteristics and towing tips ..... 97
- E**
- Easytronic..... 89
  - Electric adjustment ..... 29
  - Electronic driving programmes ... 90
  - End-of-life vehicle recovery ..... 100
  - Engine compartment fuse box ... 113
  - Engine coolant ..... 102

|   |          |   |        |                                      |         |
|---|----------|---|--------|--------------------------------------|---------|
| Engine coolant temperature gauge .....              | 64       | <b>G</b>  |        | Interior care .....                  | 134     |
| Engine data .....                                   | 141      | General information .....                       | 97     | Interior lights .....                | 78, 111 |
| Engine exhaust .....                                | 86       | Glovebox .....                                  | 47     | Interruption of power supply .....   | 91      |
| Engine oil .....                                    | 101, 136 | Graphic-Info-Display, Colour-Info-Display ..... | 70     | Introduction .....                   | 3       |
| Engine oil pressure .....                           | 68       | <b>H</b>  |        | Isofix child restraint systems ..... | 46      |
| Event data recorders .....                          | 155      | Halogen headlights .....                        | 105    | <b>J</b>                             |         |
| Exterior care .....                                 | 132      | Hand brake .....                                | 93     | Jump starting .....                  | 129     |
| Exterior lighting .....                             | 11       | Hazard warning flashers .....                   | 76     | <b>K</b>                             |         |
| <b>F</b>  |          | Headlight flash .....                           | 75     | Keys .....                           | 17      |
| Fault .....   | 91       | Headlight range adjustment .....                | 76     | <b>L</b>                             |         |
| First aid kit .....                                 | 53       | Headlights when driving abroad ..               | 76     | Light switch .....                   | 75      |
| Fixed air vents .....                               | 82       | Head restraint adjustment .....                 | 8      | Load compartment .....               | 24, 49  |
| Fog light .....                                     | 69       | Head restraints .....                           | 33     | Load compartment cover .....         | 49      |
| Fog lights .....                                    | 109      | Heated .....                                    | 30     | Load compartment grille .....        | 51      |
| Folding .....                                       | 29       | Heated rear window .....                        | 32     | Load compartment lighting .....      | 78      |
| Front airbag system .....                           | 40       | Heating .....                                   | 36     | Loading information .....            | 54      |
| Front fog lights .....                              | 77       | Heating and ventilation system ..               | 80     | Low engine oil level .....           | 69      |
| Front turn signal lights .....                      | 109      | High beam .....                                 | 69, 75 | Low fuel .....                       | 69      |
| Fuel consumption - CO <sub>2</sub> -Emissions ..... | 96, 142  | Horn .....                                      | 13, 57 | <b>M</b>                             |         |
| Fuel for diesel engines .....                       | 94       | <b>I</b>  |        | Malfunction indicator light .....    | 67      |
| Fuel for natural gas operation .....                | 94       | Identification plate .....                      | 139    | Manual adjustment .....              | 29      |
| Fuel for petrol engines .....                       | 94       | Ignition switch positions .....                 | 85     | Manual anti-dazzle .....             | 30      |
| Fuel gauge .....                                    | 62       | Immobiliser .....                               | 28     | Manual transmission .....            | 88      |
| Fuel selector .....                                 | 63       | Instrument panel illumination .....             | 112    | Manual transmission automated ..     | 89      |
| Fuses .....   | 113      | Instrument panel illumination control .....     | 78     | Manual windows .....                 | 30      |
|   |          | Instrument panel overview .....                 | 11     |                                      |         |

|  |        |  |         |   |        |
|--|--------|--|---------|---|--------|
| Mirror adjustment .....                        | 8      | Rear fog lights .....                      | 77      | Sun visors .....                              | 32     |
| Misted light covers .....                      | 77     | Rear window wiper/washer .....             | 58      | Symbols .....                                 | 4      |
| <b>N</b>                                       |        | Recommended fluids and<br>lubricants ..... | 136     | <b>T</b>                                      |        |
| New vehicle running-in .....                   | 84     | Refuelling .....                           | 95      | Tachometer .....                              | 62     |
| Number plate light .....                       | 110    | Roof rack .....                            | 54      | Tail lights .....                             | 109    |
| <b>O</b>                                       |        | <b>S</b>                                   |         | Three-point seat belt .....                   | 38     |
| Odometer .....                                 | 61     | Safety net .....                           | 50      | Tools .....                                   | 118    |
| Outside temperature .....                      | 58     | Seat adjustment .....                      | 7, 35   | Towing another vehicle .....                  | 132    |
| Overhead console .....                         | 48     | Seat belt .....                            | 8       | Towing hitch installation<br>dimensions ..... | 154    |
| Overrun cut-off .....                          | 85     | Seat belts .....                           | 37      | Towing the vehicle .....                      | 131    |
| <b>P</b>                                       |        | Seat folding .....                         | 36      | Trailer towing .....                          | 98     |
| Parking .....                                  | 16, 86 | Seat position .....                        | 34      | Transmission .....                            | 15     |
| Parking brake .....                            | 93     | Selector lever .....                       | 89      | Transmission display .....                    | 65, 89 |
| Particle filter .....                          | 86     | Service .....                              | 83, 135 | Tread depth .....                             | 120    |
| Performance .....                              | 142    | Service display .....                      | 64      | Triple-Info-Display .....                     | 70     |
| Performing work .....                          | 100    | Service information .....                  | 135     | Trip odometer .....                           | 61     |
| Pollen filter .....                            | 82     | Service vehicle soon .....                 | 67      | Turn and lane-change signals .....            | 77     |
| Power outlets .....                            | 59     | Side airbag system .....                   | 40      | Turn signal .....                             | 67     |
| Power steering .....                           | 68     | Sidelights .....                           | 75      | Tyre chains .....                             | 121    |
| Power windows .....                            | 31     | Side turn signal lights .....              | 110     | Tyre designations .....                       | 119    |
| Preheating and diesel particle<br>filter ..... | 68     | Sliding door .....                         | 23      | Tyre pressure .....                           | 120    |
| <b>R</b>                                       |        | Spare wheel .....                          | 127     | Tyre pressures .....                          | 149    |
| Radio remote control .....                     | 18     | Speedometer .....                          | 61      | Tyre repair kit .....                         | 121    |
| Reading lights .....                           | 78     | Starting off .....                         | 15      | <b>U</b>                                      |        |
| Rear fog light .....                           | 69     | Starting the engine .....                  | 85, 89  | Underseat storage .....                       | 48     |
|  |        | Steering wheel adjustment .....            | 9, 56   | Using this manual .....                       | 3      |
|  |        | Steering wheel controls .....              | 56      |   |        |
|  |        | Sunglasses storage .....                   | 47      |   |        |

**V**

|                                    |     |
|------------------------------------|-----|
| Vehicle dimensions .....           | 145 |
| Vehicle Identification Number .... | 139 |
| Vehicle specific data .....        | 3   |
| Vehicle storage.....               | 99  |
| Vehicle unlocking .....            | 6   |
| Vehicle weight .....               | 144 |
| Ventilation.....                   | 80  |

**W**

|                                |     |
|--------------------------------|-----|
| Warning chimes .....           | 74  |
| Warning triangle .....         | 52  |
| Washer and wiper systems ..... | 13  |
| Washer fluid .....             | 103 |
| Wheel changing .....           | 124 |
| Wheel covers .....             | 121 |
| Wheels and tyres .....         | 119 |
| Windscreen wiper/washer .....  | 57  |
| Winter mode .....              | 68  |
| Winter tyres .....             | 119 |
| Wiper blade replacement .....  | 104 |

